



MULTI-DROP ASCII

COMMUNICATIONS REFERENCE





IMPORTANT

- Please read all the information in this reference before you install the product.
- This reference assumes a full working knowledge of the relevant host controller (network master computer).

NOTICE

The products and services described in this manual are useful in a wide variety of applications. Therefore, the user and others responsible for applying the products and services described herein are responsible for determining their acceptability for each application. While efforts have been made to provide accurate information within this manual, Spectrum Controls assumes no responsibility for the accuracy, completeness or usefulness of the information contained herein.

Under no circumstances will Spectrum Controls be responsible or liable for any damages or losses, including indirect or consequential damages or losses, arising out of either the use of any information contained within this manual or the use of any product or service referenced herein.

No patent liability is assumed by Spectrum Controls with respect to the use of any of the information, products, circuits, programming or services referenced herein.

The information contained in this manual is subject to change without notice.

LIMITED WARRANTY

Spectrum Controls warrants that its products are free from defects in material and workmanship under normal use and service, as described in Spectrum Controls literature covering this product, for a period of 1 year. Spectrum Controls' obligations under this warranty are limited to replacing or repairing, at its option, at its factory or facility, any product which shall, in the applicable period after shipment, be returned to Spectrum Controls' facility, transportation charges prepaid, and which after examination is determined, to the satisfaction of Spectrum Controls, to be thus defective.

This warranty shall not apply to any such equipment which shall have been repaired or altered except by Spectrum Controls or which shall have been subject to misuse, neglect or accident. In no case shall Spectrum Controls' liability exceed the purchase price. The aforementioned provisions do not extend the original warranty period of any product which has either been repaired or replaced by Spectrum Controls.



CAUTION

Spectrum Controls' devices contain electronic components which are susceptible to damage from electrostatic discharge. A static charge can accumulate on the surface of ordinary plastic wrapping or cushioning material. If any Spectrum Controls' device must be returned to Spectrum Controls, the following packaging instruction must be followed:

PREFERRED: Use the original packaging material as supplied by Spectrum Controls. Place the device inside the conductive plastic bag.

ACCEPTABLE: Wrap the device in some type of antistatic material. Antistatic plastic material can be identified by its pink color, and can be obtained in sheet or bag form.

UNACCEPTABLE: Do not use ordinary plastic film, foam, or styrene chips ("popcorn" or "peanuts"). These materials can accumulate charges in excess of 10,000 volts, resulting in possible damage to the Spectrum Controls electronic device.

Antistatic (metallized plastic) bags can be obtained from the following manufacturers:

3M Company	(800-328-1368)	Type 2100 bag
Static, Inc.	(800-782-8424)	8000 Series bag
Charles Water	(617-964-8370)	CP-303 bag

Copyright and Trademark information

SOI and SOI-SPS are trademarks of Spectrum Controls, Inc.

IBM is a registered trademark of International Business Machines Corporation.

MS-DOS is a registered trademark of Microsoft Corporation.

All other trademarks belong to their respective owners.

© 1998 Spectrum Controls, Inc. All rights reserved.

Specifications subject to change without notice. Printed in U.S.A.



CONTENTS

PREFACE	1
Background	1
Who Should Use this Reference	3
Related Documents	3
Terminal Mode	3
Point-to-Point Operation	4
CHAPTER 1: CONFIGURING	5
Setting DIP Switches	5
Using the SOI-SPS Programming Software	7
Using the SOI-260's F Key	9
Using the Network Master Computer	11
CHAPTER 2: CONNECTING TO THE NETWORK	13
CHAPTER 3: SENDING COMMANDS	15
Addressing	15
The Command Protocol	16
Supported Display Characters	24
Supported Control Codes	26
An Example Session	27



CHAPTER 4: ENTERING DATA.....	31
Keypad Entry	31
“Arcade” Entry of ASCII Characters	35
Direct ASCII Code Entry	36
CHAPTER 5: TROUBLESHOOTING	37
General Symptoms and Solutions	37
Resetting Your SOI-260.....	38
APPENDIX A: EXAMPLE APPLICATION	39
INDEX	43



PREFACE

Read this preface to familiarize yourself with the rest of this Reference. This preface covers:

- background
- who should use this guide
- what this Reference covers
- related documents
- terminal mode
- point-to-point operation

This Reference covers the information needed to use an SOI-260 operator interface product with a Multi-Drop RS-485 network. The Reference contains the information you need to configure, install, and use an SOI-260. This Reference also provides troubleshooting help should the need arise.

Please read all the information in this reference before you install or use your SOI-260.

Background

The Multi-Drop ASCII protocol lets you develop programs that control one or more SOI-260s from an IBM-compatible PC using a standard comm port. The user simply implements the control logic in a programming language such as BASIC.



A Multi-Drop network consists of a host controller (an IBM-compatible personal computer), called the “network master,” and a number of SOI-260 operator interfaces connected via an RS-485 data link. An RS232-to-RS485 converter must be used to interface a standard PC comm port to more than one SOI-260.

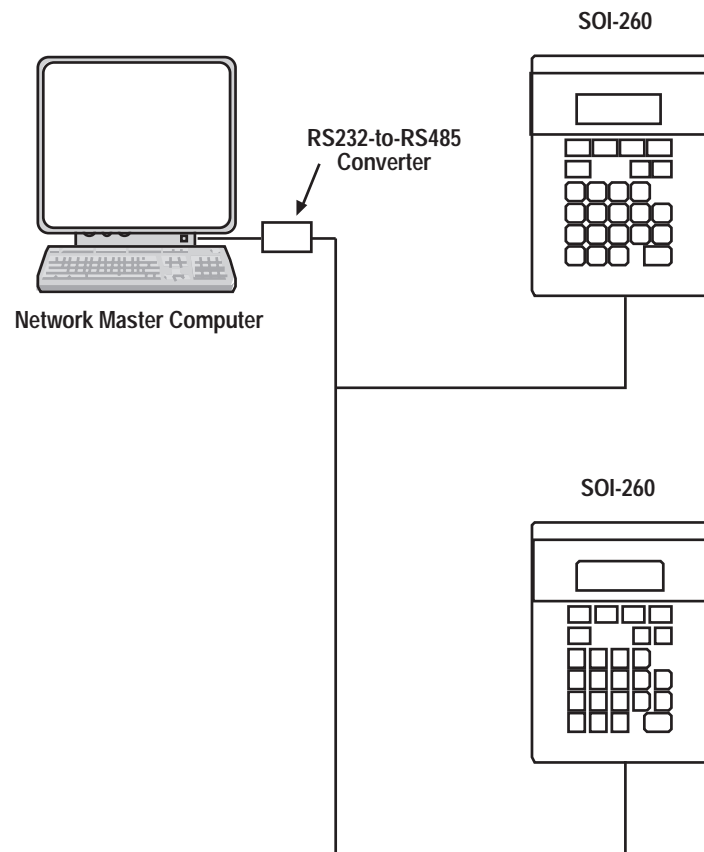

The network master initiates all communications, sends commands (strings of ASCII characters) across the data link, and polls the SOI-260s for responses. To prevent all of the SOI-260s from responding at the same time, each SOI-260 is assigned a unique network address.

Messages from the PC may include a variety of commands to update text and position the cursor on an SOI-260's display. In addition, each SOI-260 buffers operator keystrokes, which may then be polled by the PC's control program.



Who Should Use this Reference

Use this Reference if you design, install, program, or maintain a control system that uses a Multi-Drop RS-485 network.

This reference assumes a full working knowledge of the relevant network master computer.

You should have a basic understanding of computer products. If you do not, contact your local distributor for the proper training before using these products.

Related Documents

The following table lists related documents that may help you as you install and use these products:

Publication Number	Title
0300050	SOI-260 Operator Interface User Manual
0300054	SOI-SPS Programming Software Manual
0300063	Upload/Download Cable For SOI-120 and SOI-260

Terminal Mode

The *SOI-260 Operator Interface User Manual* (publication 0300050) contains information on the SOI-260's **terminal mode**. In terminal mode, the SOI-260 operates as a simple terminal: each key pressed on the SOI-260's keypad causes a character to be sent out the SOI-260's communications port. Displayable ASCII characters sent into its communications port are displayed on the SOI-260's 4x20 screen.



Point-to-Point Operation

The SOI-260 can also operate in an RS-232 mode, providing a point-to-point connection to the network master computer.

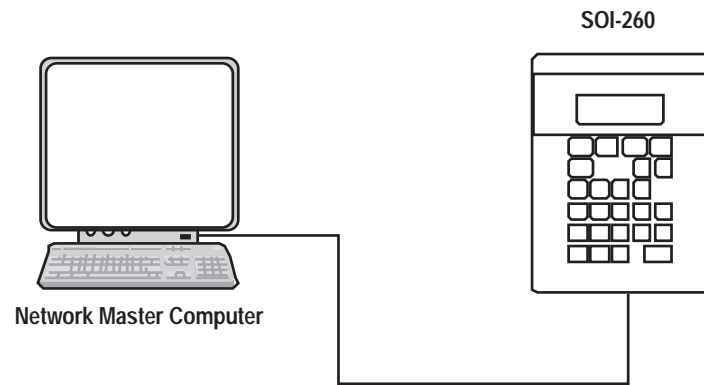

CHAPTER 1: CONFIGURING

Read this chapter of the *Multi-Drop ASCII Communications Reference* to configure your SOI-260. This chapter covers:

- setting DIP switches
- using the SOI-SPS programming software
- using the SOI-260's F key menu
- using the network master computer

Setting DIP Switches

Your SOI-260 provides a 6-position DIP switch under a removable plastic cover on the back of the unit:

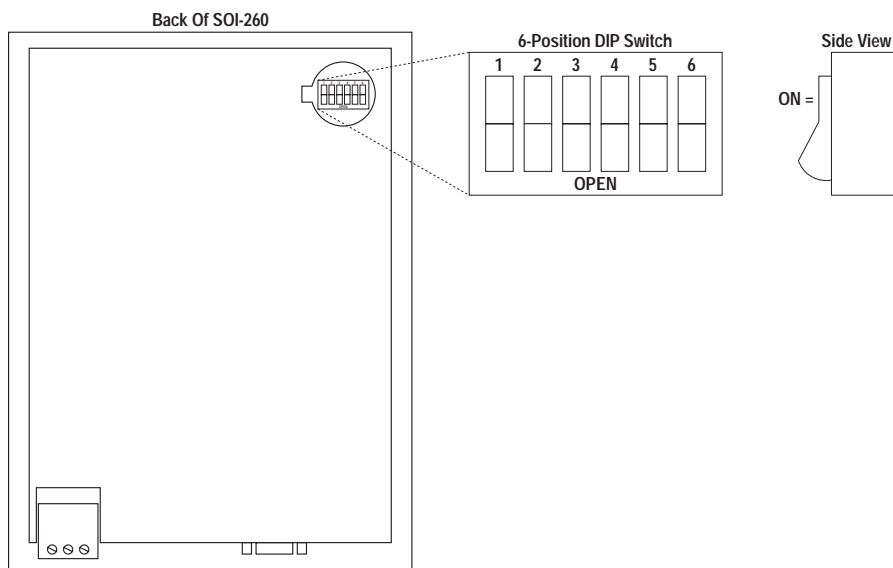



This DIP switch controls the following functions:

Switch Position	Function	Setting*	Effect
1	Upload/Download Enable	ON	Enables upload/download so you can upload and download SOI-260 "program files" (.CFG files) and a new operating system (OS).
		OFF	Disables upload/download and sets unit to run.
2	Comm Port Setting	ON	Sets Comm port for RS-485 communications.
		OFF	Sets Comm port for RS-232 communications.
3	Master Security Enable		Not used for this protocol.
4	"F" Key Enable	ON	Enables "F" Key menu.
		OFF	Disables "F" Key menu.
5	Terminal Mode Enable	ON	Enables terminal mode. Requires reset to take effect, either by toggling DIP switch 1, using the "F" Key menu reset option, or cycling power. Do not enable terminal mode if you want to use the Multi-Drop ASCII protocol.
		OFF	Disables terminal mode so you can use the Multi-Drop ASCII Communications protocol.
6	Comm Up/Download Enable	ON	Enables Comm Port for up/download.
		OFF	Disables Comm Port for up/download.

* Factory default in bold.

Example 1

Use the following switch settings to download an SOI-260 "program file" (.CFG file) using the Comm Port and **RS-232** communications:

1	2	3	4	5	6
ON	OFF	ON	ON	OFF	ON

Example 2

Use the following switch settings to download an SOI-260 "program file" (.CFG file) using the Comm Port and **RS-485** communications:

1	2	3	4	5	6
ON	ON	ON	ON	OFF	ON



Example 3: After downloading the SOI-260 “program file” (.CFG file), use the following switch settings before connecting your SOI-260 to a multi-drop RS-485 network:

1	2	3	4	5	6
OFF	ON	ON	ON	OFF	ON

Using the SOI-SPS Programming Software

Before you can use your SOI-260, you must edit its “program file” (identified with a “.CFG” extension). To do this, connect your SOI-260 to a personal computer and use the SOI-SPS Programming Software to edit and download the program file. You may use either the SOI-260’s communications port or optional printer port to upload or download the program file from a personal computer.

Appendix A shows the required cabling and connections when building your own cable. If you don’t want to build your own cable, Spectrum Controls offers the SCC-3 cable for uploading and downloading application programs:

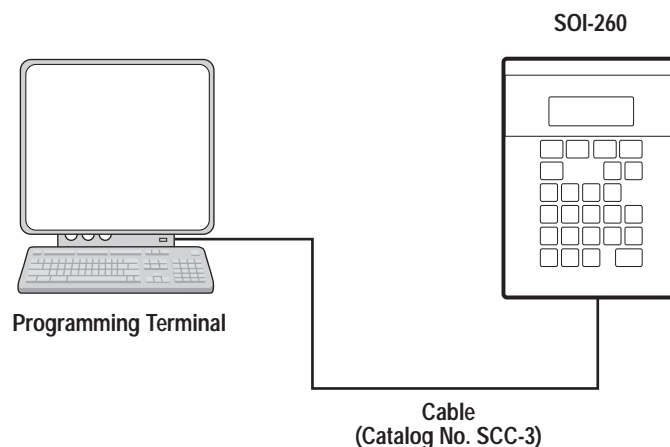

See the *SOI-SPS Programming Software Manual* (publication 0300054) for information on how to install and use this software.



After installing and running SOI-SPS...

1. Select the “EDIT PROGRAM FILE” item from the SOI-200 SERIES OPENING MENU.

SOI-200 SERIES OPENING MENU
<p>EDIT PROGRAM FILE DOWNLOAD FILE TO SOI-200 SERIES UPLOAD FILE FROM SOI-200 SERIES OUTPUT HARD COPY OF FILE UPGRADE OPERATING SYSTEM</p>
<p>USE ↑↓ KEYS TO CHOOSE AN ITEM. PRESS 'ENTER' TO SELECT.</p> <p>PRESS 'ESC' TO EXIT.</p>
<p>EDIT PROGRAM FILE USE TO CREATE OR MODIFY A SOI-200 SERIES PROGRAM FILE. A MODIFIED FILE CAN BE SAVED UNDER A NEW NAME.</p>

2. Enter a name for your program file.
3. Select “SOI 260 MULTIDROP.”

Using SOI-SPS, you may change any of the following parameters:

	Parameter	Possible Values
Comm. Port	Baud rate	300, 1200, 2400, 4800, 9600 , or 19200, 38400
	Parity	Even, odd, or none
	Data bits	7 or 8
Terminal Setting	Response terminator	ETX , CR, LF, or CR/LF
	Keypad	Disabled or enabled
Display	Entry echo	Disabled or enabled
	Cursor	Disabled, underlined, or flashing block
Node Address	Node address	01 hex to FF hex

* **Factory default in bold.**



After changing any of these parameters, save the .CFG file, and select the “DOWNLOAD FILE TO SOI-200 SERIES” item in the “SOI-200 SERIES OPENING MENU” to update the configuration of your SOI-260. If your SOI-260 already has another Operating System loaded, you will be prompted to download the SOI-260 Multi-Drop protocol.

Note: Once you have properly configured your SOI-260 and set DIP switch 1 OFF (to disable upload/download) and DIP switch 4 ON (to enable the “F” key menus), you may change these same parameters using the F key on the SOI-260, as described in the following subsection.

Using the SOI-260's F Key

After downloading the program file, you may reconfigure your SOI-260 using the SOI-260's F key menus.

Note: While you use the F key menus, your SOI-260 cannot display or respond to commands from the network master computer.



The following figure shows the F key menus that appear on the SOI-260 display and the key presses linking them together:

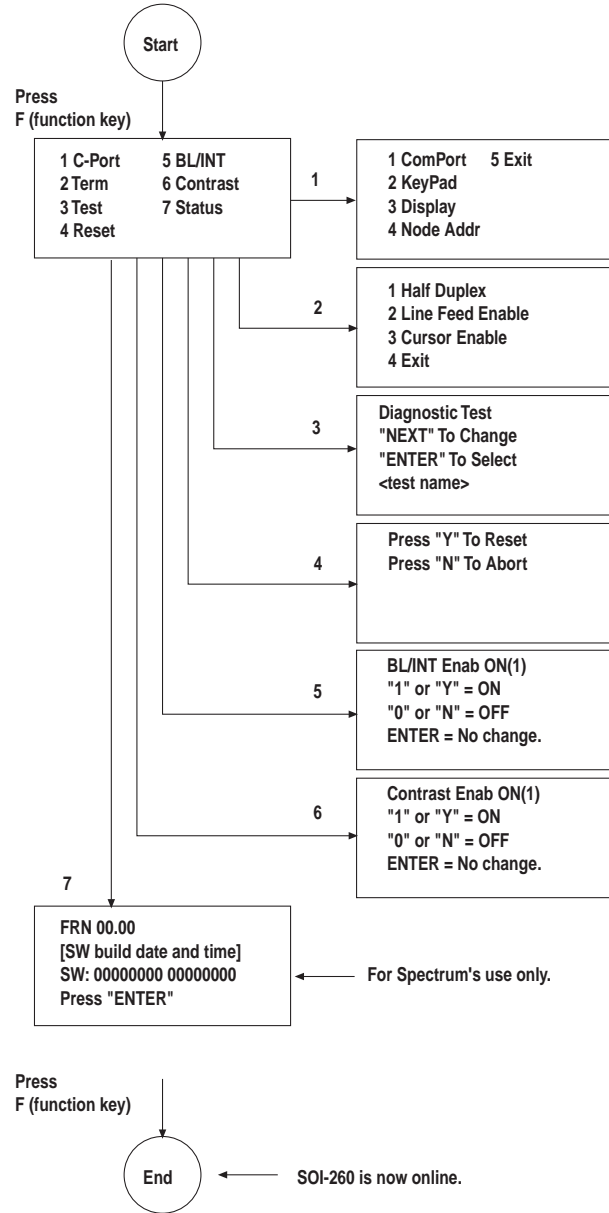



After pressing the F key and selecting menu item 1 (ComPort), you may change any of the following parameters:

Menu Choice	Parameter	Possible Values
ComPort	Baud rate	300, 1200, 2400, 4800, 9600 , or 19200, 38400
	Parity	Even, odd, or none
	Data bits	7 or 8
KeyPad	Response terminator	ETX , CR, LF, or CR/LF
	Keypad	Disabled or enabled
Display	Entry echo	Disabled or enabled
	Cursor	Disabled, underlined, or flashing block
Node Addr	Node address	01 hex to FF hex

* Factory default in bold.

Note: You may also change these parameters using the SOI-SPS Programming Software.

Using the Network Master Computer

After properly configuring your SOI-260 and connecting it to a Multi-Drop RS-485 network, you may reconfigure your SOI-260 by sending commands from the host controller (network master computer).

Using the appropriate command, you may change any of the following parameters:

Command	Parameter	Possible Values
T	Response terminator	ETX , CR, LF, or CR/LF
k	Keypad	Disabled or enabled
f	Entry echo	Disabled or enabled
N	Node address	01 hex to FF hex

* Factory default in bold.



CHAPTER 2: CONNECTING TO THE NETWORK

Read this chapter of the *Multi-Drop ASCII Communications Reference* to connect your SOI-260 to a multi-drop RS-485 network. This chapter covers the cabling needed to use the SOI-260's communications port with RS-485 communications enabled.

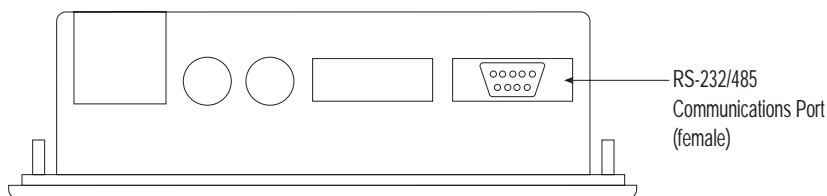

For information on mounting the SOI-260, as well as connecting power and wiring, see the *SOI-260 Operator Interface User Manual* (publication 0300050).

Note: *Before connecting your SOI-260 to a multi-drop RS-485 network, you need to reset the SOI-260 DIP switches to disable upload/download and enable RS-485 communications. See Example 3 in Chapter 1 of this reference.*



Connect your SOI-260 to the Multi-Drop RS-485 network as shown in the following figure:

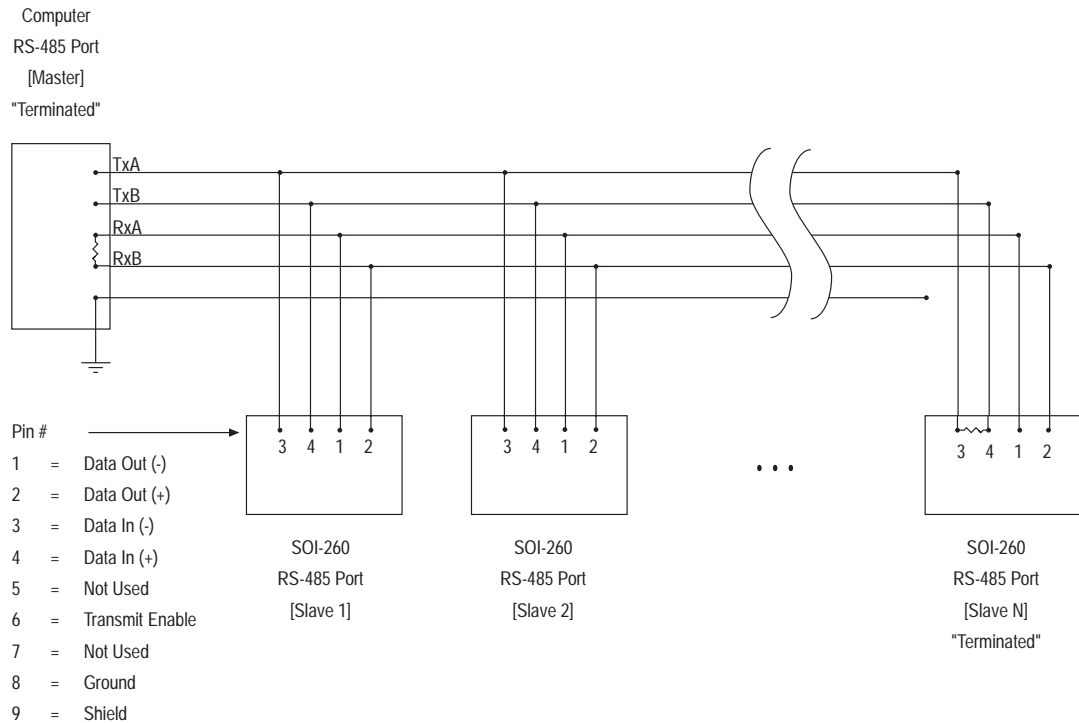

Note: *You should terminate the network master computer and the last SOI-260 with a 120Ω resistor. You should also connect the shield wire to ground at the master computer.*

The preceding figure shows a typical multi-drop 4-wire (plus shield wire) connection.

CHAPTER 3: SENDING COMMANDS

Read this chapter of the *Multi-Drop ASCII Communications Reference* to become familiar with sending commands to your SOI-260 from a host controller (network master computer). This chapter covers:

- addressing
- the command protocol
- supported display characters
- supported control codes
- an example session

Addressing

To communicate with an SOI-260, the network master computer sends commands (strings of ASCII characters) across the network. These commands always start with the SOI-260's unique node address followed by a strictly defined set of characters. An ETX, STX, ETX/STX, or STX/ETX character signifies the end of the command line.

Each SOI-260 on the network continually evaluates these sent commands, checking to see if the node address matches its internal node address. If the command does not contain its node address, the command is ignored and the SOI-260 continues listening for the next command from the network master computer.



If the network master wants to send an identical message to all of the SOI-260s on the network, it can use the “global broadcast” node address of “00”. By using the global address, the master can send data to all the terminals at once.

Note: Do not use node address “00” with commands that require a response (such as Status or Echo). Also, always ensure that each terminal has a unique node addresses. Otherwise, bus contention may occur.

The Command Protocol

To communicate on the network, the master computer must format its messages according to the following syntax:

[ID]ESC[command][command data][terminator]

Where:

[ID] = 2 ASCII characters (00 to FF). This is the node address of the terminal. MUST BE IN ALL CAPS.

ESC = ASCII **escape** character (1B hex)

[command] = ASCII command character (case sensitive)

[command data] = ASCII character(s) required by the specific command code.

[command terminator] = **STX** (02 hex), **ETX** (03 hex), **STX/ETX**, or **ETX/STX**.

In each of the following examples, a Node Address of “02” and a response terminator of “ETX” are used, and an “STX” is used as the command terminator from the master computer.

Note: If the network master computer sends an incomplete or illegal command, the SOI-260 ignores the command. There is no visible indication that the network master computer sent an illegal command.



Configuration Commands

Command	Description
N	Set Node Address Changes the SOI-260 Node Address. Possible node addresses are 01 to FF (2 ASCII characters). Address values must be in all caps. Command Format: [id] ESC N[address] STX Returns: No response. [id]: 01 to FF (note: Letters must be all caps). Note: if global address 00 is used, this command is ignored. [address]: 01 to FF Example: 02 ESC N FESTX Changes the SOI-260 node address to FE (254 decimal).
T	Set Response Terminator Sets the line terminator to be returned by the SOI-260. This is the character(s) that is appended to any returned data. Command Format: [id] ESC T[terminator] STX Returns: No response. [id]: 01 to FF (note: Letters must be all caps) [Terminator]: 0 = (ETX), 1 = (CR), 2 = (LF), 3 = (CR/LF) Example: 02 ESC T 0STX Sets the current line terminator to " ETX ".



c Request Configuration Parameters

Sends configuration parameters back to the master.

Command Format: [id]**ESCcSTX**

Returns: [id][Class][Version][Revision][Serial][Response Terminator]

[id]: 01 to FF (note: Letters must be all caps)

[Class]: 2 characters (SOI-260 = 26)

[Version]: 2 characters (00 to FF)

[Revision]: 2 characters (00 to FF)

[Serial]: 1 character (0 = RS232, 1 = RS485)

[Response Terminator]: **ETX**, CR, LF or CR/LF

Example: 02**ESCcSTX**

Request configuration parameters of the SOI-260. Note all fields must be specified. The SOI-260 will return the following characters: 02260A021**ETX** (assuming the software version and revision of the SOI-260 is '0A.02' and RS-485 communications are enabled).

e Echo Back Text

Causes the SOI-260 to echo back the ASCII characters sent as the text argument of the command line (followed by a line terminator). This can be used by the master computer to verify that the terminal is properly connected to the serial link.

Command Format: [id]**ESCe[text]STX**

Returns: [id][text][response terminator]

[id]: 01 to FF (note: Letters must be all caps)

[text]: test message (50 character max). Note: if >50 characters, this command is ignored.

[response terminator]: **ETX**, CR, LF or CR/LF

Example: 02**ESCeHello world!!STX**

Commands the SOI-260 to echo back "02Hello world!!**ETX**"



F Flash Alarm LED

Turns on or turns off the alarm LED as indicated by the option parameter.

Command Format: [id]**ESCF**[option]**STX**

Returns: No response.

[id]: 01 to FF (note: Letters must be all caps)

[option]: 0 = (Alarm Light Off), 1 = (Alarm Light Blinking)

Example: 02**ESCF1STX**

Turns on the alarm light (blinking).

Keypad Commands

Command	Description
---------	-------------

k	Keypad Control
----------	-----------------------

Allows master computer control over the keypad operation.

Command Format: [id]**ESCK**[enable]**STX**

Returns: No response.

[id]: 01 to FF (note: Letters must be all caps)

[enable]: 0 = No change, 1 = Disable all keypad entry (Except for Function, Contrast and BackLight key), 2 = Enable keypad entry

Example: 02**ESCK1STX**

The following command disables all keypad entry except for the Function Key "F", Contrast and BackLight key.

f	Entry Echo
----------	-------------------

Allows the master computer to control the keypad/display echo during keypad input.

Command Format: [id]**ESCF**[entry echo]**STX**

Returns: No response.

[id]: 01 to FF (note: Letters must be all caps)

[entry echo]: 0 = No change, 1 = Display "*" during entry, 2 = Enable keypad echo

Example: 02**ESCF1STX**

Displays "*" during keypad entry.



o Clear Output (keypad) Buffer

Clears the contents of the SOI-260's keypad buffer. This allows the master computer to cancel the operator's input for important status messages of other critical displays. This command re-enables keypad entry, sets keypad status to "no key entered," and clears the keypad buffer. Note: this command does not clear the retransmit keypad buffer.

Command Format: [id]**ESCoSTX**

Returns: No response.

[id]: 01 to FF (note: Letters must be all caps)

Example: 02**ESCoSTX**

Clears the output buffer.

p Poll Terminal for Operator Input

Returns the contents of the SOI-260's keypad buffer. This will return message data if the terminal is in an 'output pending' state, otherwise Node ID and a line terminator is returned to the master computer. If data is polled, the keypad buffer is automatically cleared. The keypad is then re-enabled and keypad status is set to "no keys entered".

Command Format: [id]**ESCpSTX**

Returns: [id][data][response terminator]

[id]: 01 to FF (note: Letters must be all caps)

Example: 02**ESCpSTX**

Polls the terminal for operator input. Returns: 1234**ETX** (after the operator entered 1,2,3 and 4 and then pressed the enter key), and clears the keypad buffer.

r Retrieve Last Keypad Input

Returns the last keypad entry. Note: the last keypad entry is cleared only when function key is pressed or after a full unit reset.

Command Format: [id]**ESCrSTX**

Returns: [id][text][response terminator]

[id]: 01 to FF (note: Letters must be all caps)

Example: 02**ESCrSTX**

Retrieves the last keypad entry.



? Request Keypad Status

Returns the status of the SOI-260's keypad input buffer. This command will return the Node ID followed by one of the following codes: 0 = No keys entered 1 = Key input in progress 2 = Key buffered, ready for poll command.

Command Format: [id]**ESC?STX**

Returns: [id][status][response terminator]

[id]: 01 to FF (note: Letters must be all caps)

[status]: '0' = No Key buffered, '1' = Keys are being entered, '2' = Keys are buffered (in other words, Enter key has been pressed)

Example: 02**ESC?STX**

Requests keypad status for node 2. Returns: 020**ETX** (if no keys have been pressed).

Display Commands

Command	Description
---------	-------------

C Clear Screen

Clears the screen and set cursor position back to column 1, row 1. This command also clears the keypad buffer and sets keypad status to "no keys entered".

Command Format: [id]**ESCCSTX**

Returns: No response.

[id]: 01 to FF (note: Letters must be all caps)

Example: 02**ESCCSTX**

Clears the screen and moves cursor back to col#1, row#1.



i Set Cursor Position

Allows the master computer to move the cursor to the desired position without affecting the display contents. This command also clears the keypad buffer and sets the keypad status to "no keys entered".

Command Format: [id]**ESC**i[column] [line]**STX**

Returns: No response.

[column]: 00 = No change, 01-20 = move cursor to desired column

[line]: 0 = No change, 1-4 = move to desired line number

Example: 02**ESC**i032**STX**

Moves the cursor to col#3, line#2. Note: all fields must be specified.

x Set Cursor Position and write text

Allows the master computer to write up to 20 characters to the SOI-260 screen, depending on the initial cursor position. The text location is specified by column number and line number. Once this command is executed, it also clears the keypad buffer and sets the keypad status to "no keys entered".

Command Format: [id]**ESC**x[column] [line] [text]**STX**

Returns: No response.

[id]: 01 to FF (note: Letters must be all caps)

[column]: 00 = No change, 01-20 = move cursor to desired column

[line]: 0 = No change, 1-4 = move to desired line number

[text]: text message (Any message longer than the screen will be truncated).

Example: 02**ESC**x012HELLO**STX**

Displays 'HELLO' text starting on col#1 line #2 Note: all fields must be specified.



y **Read Cursor Position**

Allows the network master computer to read the current cursor position. The column is returned as two digits from 01 to the maximum line length (20 for SOI-260). The line is returned as two digit (01, 02, 03 or 04) by the SOI-260.

Command Format: [id]**ESCySTX**

Returns: [id][column][line][response terminator]

[id]: 01 to FF (note: Letters must be all caps)

[column]: '01'-'20' = Column number

[line]: '01'-'04' = Row number

Exapmle:02**ESCySTX**

Returns cursor position. Note: all fields must be specified. Returns: 021904**ETX**
(cursor is at column 19, line 4)



Supported Display Characters

The following charts show the supported ASCII display characters and their corresponding Decimal and Hexadecimal codes.

DEC	HEX	CHR
32	20	
33	21	!
34	22	"
35	23	#
36	24	\$
37	25	%
38	26	&
39	27	'
40	28	(
41	29)
42	2A	*
43	2B	+
44	2C	,
45	2D	-
46	2E	.
47	2F	/
48	30	0
49	31	1
50	32	2
51	33	3
52	34	4
53	35	5
54	36	6
55	37	7

DEC	HEX	CHR
56	38	8
57	39	9
58	3A	:
59	3B	;
60	3C	<
61	3D	=
62	3E	>
63	3F	?@
64	40	0
65	41	1
66	42	2
67	43	3
68	44	4
69	45	5
70	46	6
71	47	7
72	48	8
73	49	9
74	4A	A
75	4B	B
76	4C	C
77	4D	D
78	4E	E
79	4F	F

DEC	HEX	CHR
80	50	P
81	51	Q
82	52	R
83	53	S
84	54	T
85	55	U
86	56	V
87	57	W
88	58	X
89	59	Y
90	5A	Z
91	5B	[
92	5C]
93	5D	^
94	5E	_
95	5F	`
96	60	a
97	61	b
98	62	c
99	63	d
100	64	e
101	65	f
102	66	g
103	67	h

**All of the above characters are supported when 8-bit communications is enabled. Hex codes below 80H are supported by 7-bit communications.*



DEC	HEX	CHR
104	68	h
105	69	i
106	6A	j
107	6B	k
108	6C	l
109	6D	m
110	6E	n
111	6F	o
112	70	p
113	71	q
114	72	r
115	73	s
116	74	t
117	75	u
118	76	v
119	77	w
120	78	x
121	79	y
122	7A	z
123	7B	[
124	7C]
125	7D	^
126	7E	_
127	7F	`

DEC	HEX	CHR
160	A0	
161	A1	。
162	A2	、
163	A3	、
164	A4	、
165	A5	、
166	A6	マ
167	A7	ア
168	A8	イ
169	A9	ウ
170	AA	エ
171	AB	オ
172	AC	カ
173	AD	ク
174	AE	ケ
175	AF	コ
176	B0	ー
177	B1	ア
178	B2	イ
179	B3	ウ
180	B4	エ
181	B5	オ
182	B6	カ
183	B7	キ

DEC	HEX	CHR
184	B8	ク
185	B9	ケ
186	BA	コ
187	BB	サ
188	BC	シ
189	BD	ス
190	BE	セ
191	BF	ソ
192	C0	タ
193	C1	チ
194	C2	テ
195	C3	ト
196	C4	フ
197	C5	ボ
198	C6	ブ
199	C7	パ
200	C8	ピ
201	C9	ポ
202	CA	プ
203	CB	ペ
204	CC	ポ
205	CD	プ
206	CE	ホ
207	CF	マ

*All of the above characters are supported when 8-bit communications is enabled. Hex codes below 80H are supported by 7-bit communications.



DEC	HEX	CHR	DEC	HEX	CHR
208	D0	ニ	232	E8	フ
209	D1	ヅ	233	E9	フ
210	D2	ヅ	234	EA	フ
211	D3	ヅ	235	EB	フ
212	D4	ヅ	236	EC	フ
213	D5	ヅ	237	FD	フ
214	D6	ヅ	238	EE	フ
215	D7	ヅ	239	EF	フ
216	D8	ヅ	240	F0	フ
217	D9	ヅ	241	F1	フ
218	DA	ヅ	242	F2	フ
219	DB	ヅ	243	F3	フ
220	DC	ヅ	244	F4	フ
221	DD	ヅ	245	F5	フ
222	DE	ヅ	246	F6	フ
223	DF	ヅ	247	F7	フ
224	E0	ヅ	248	F8	フ
225	E1	ヅ	249	F9	フ
226	E2	ヅ	250	FA	フ
227	E3	ヅ	251	FB	フ
228	E4	ヅ	252	FC	フ
229	E5	ヅ	253	FD	フ
230	E6	ヅ	254	FE	フ
231	E7	ヅ	255	FF	フ

** All of the above characters are supported when 8-bit communications is enabled. Hex codes below 80H are supported by 7-bit communications.*

Supported Control Codes

The only control codes supported by the SOI-260 are STX (02 hex), ETX (03 hex), and ESC (1B hex), as defined in the command protocol. If these supported control codes do not appear in the expected location of a command line, the SOI-260 simply ignores the command. All other control codes are “unsupported.”



If unsupported control codes appear in the “command data” field of a command line, the SOI-260 simply filters them out and continues to process the command. However, if unsupported control codes appear anywhere else, the SOI-260 ignores the entire command. The following are some examples of valid and invalid commands with control codes inserted at various locations in the command line:

Example 1

```
05ESCeHELL<unsupported code>O WOR<unsupported code>LD!!!STX
```

This command is valid and echos back “HELLO WORLD!!!” to the network master computer. The unsupported control codes appear as part of the command data; however, they are filtered out by the SOI-260

Example 2

```
05ESCeHELETXLO WORLD!!!STX
```

This command is valid but only echos back “HEL” to the network master computer. The supported control code ETX appears after “HEL.” This signals the end of the command.

Example 3

```
05<unsupported code>ESCeHELLO WORLD!!!STX
```

This command is invalid and ignored by the SOI-260. The unsupported control code appears outside the “command data” field.

Example 4

```
05ESCeHELLO WESCORLD!!!STX
```

This command is invalid and ignored by the SOI-260. The supported control code ESC appears twice in the command line: once after the node address (which is OK) and once in the “command data” field (which is not OK). The second ESC invalidates this command.

An Example Session

The following example shows a host controller (network master computer) communicating with five SOI-260 terminals on a multidrop network. The line terminator is set to an ASCII ETX character. ASCII control codes are indicated by their ASCII name in **Bold Type**.

In this example, Terminal 1 has node address 01. Terminal 2 has node address 02. Terminal 3 has node address 03. Terminal 4 has node address 10. Terminal 5 has node address 1E.



Message Sender	Message	Meaning
1. Host	00 ESC x011This is a global ETX	Displays "This is a global" on all terminals starting column 1, line 1 of the display.
2. Host	01 ESC x012Enter Driver ID: ETX	Displays "Enter Driver ID:" starting on column 1, line 2 of Terminal 1.
3. Host	01 ESC c STX	Request the Terminal 1's configuration data
4. Terminal 1	012601001 ETX	Terminal 1's data response: 01 = Node Address 26 = SOI-260 class number 01 = Software Version Number 00 = Software Revision Number 1 = Serial type (RS-485) ETX = Line terminator
5. Terminal 1		Operator Enters: "123-90" followed by the ENTER key
6. Host	01 ESC ? ETX	Host is requesting keypad status of Terminal 1.
7. Terminal 1	012 ETX	Terminal 1's data response: 01 = Node Address 2 = Keypad is buffered, ready for poll ETX = Line terminator
8. Host	01 ESC p ETX	Host is polling Terminal 1.
9. Terminal 1	01123-90 ETX	Terminal 1's data response: 01 = Node Address 123-90 = Data in output (keypad) buffer ETX = Line terminator
10. Host	1 ESC ? ETX	Host is requesting keypad status of Terminal 5.
11. Terminal 5	1E0 ETX	Terminal 5's data response: 1E = Node Address 0 = No Keys entered ETX = Line terminator
12. Host	03 ESC F1 ETX	Turn on the alarm light (flashing) of Terminal 3.



13. Host	03 ESC F0 ETX	Turn off the alarm light of Terminal 3.
----------	-----------------------------	---

14. Host	00 ESC C ETX	Clear all displays of all terminals
----------	----------------------------	-------------------------------------



CHAPTER 4: ENTERING DATA

Read this chapter of the *Multi-Drop ASCII Communications Reference* to become familiar with entering data using your SOI-260. This chapter covers:

- keypad entry
- “arcade” entry of ASCII characters
- direct ASCII code entry

Keypad Entry

The SOI-260 displays (if entry echo is enabled) all key presses without transmitting the operator’s input into the keypad buffer until the operator presses the “ENTER” key. Pressing the “ENTER” key tags the keypad buffer as ready to transmit and disables further keypad entry except for the function (F) key, backlighting/intensity key, and contrast key. At this point, the operator can re-enable data entry by pressing the function key twice (this re-initializes the unit).

When polled to do so, the SOI-260 sends the complete contents of the keypad buffer to the network master computer, including the specified line terminator, and data entry capability is re-enabled.

Note: Data entry can be re-enabled by pressing the F key twice (this re-initializes unit).



The SOI-260 entry field is limited by the size of the display. This field can be up to a maximum of 20 characters on the 4x20 display, beginning with the most current cursor position, and must be contained within one line of display. The SOI-260 uses this specific area to display the operator's input (when entry echo is enabled, otherwise "*" will be shown). The length of the entry field available depends on the initial position of the cursor. For example, if the master computer sends a command to set the cursor to column 10 of line 1, the available entry field size is 11.

If the master computer attempts to write to the terminal's display while the operator is attempting input, the SOI-260 terminates input and completely processes the master computer's message.

The following commands clear the keypad buffer and set the keypad status to "no keys entered":

- Clear Key Pad Buffer Command
- Poll Command
- Clear Screen Command
- Set Cursor Command
- Set Cursor and Write Text Command

Consequently, if a clear command (for example) was sent by the master while a user was in the middle of entering a 10 digit code (1234...), the clear screen command would be executed and the entry in process would be terminated. All the other commands do not affect the keypad buffer or keypad status.

The keys operate in the following manner:

Green Keys



MAIN MENU key

This key has no effect under the Multi-Drop ASCII protocol.



PREV MENU key

This key has no effect under the Multi-Drop ASCII protocol.

**PREV key**

Scrolls through a list of ASCII characters.

**NEXT key**

Scrolls through a list of ASCII characters.

**Y Key**

Adds a “Y” to the keypad buffer contents.

**N key**

Adds an “N” to the keypad buffer contents.

**↵ key
(Enter)**

If PREV or NEXT were used to select an ASCII character, ENTER adds the selected character to the keypad buffer contents.

If EXP were pressed, followed by a decimal value for an ASCII character, ENTER adds the selected character to the keypad buffer contents. See “Direct ASCII Code Entry” later in this chapter for more information.

Otherwise, ENTER tags the contents of the keypad buffer as ready to transmit to the master computer. Keypad entry is then disabled until the master computer requests the keypad buffer contents or re-enabled by pressing the F key twice (this re-initializes the unit).

**CE key
(Clear entry)**

The CE key deletes an entire data entry.

For example, you might enter a five digit number where the first and third digits were incorrect. By pressing the CE key, the entire value would be deleted, and you could enter a new value.

Once you press the ENTER key, the value cannot be deleted with the CLEAR ENTRY key.



**F Key
(Function key)**

The F key sets special features and operating parameters of the SOI-260. The F key is enabled or disabled by setting DIP switch 4. See Chapter 1 for more information.

When you press the Fkey, the F LED illuminates, indicating the SOI-260 is in the function mode. At this time, the function key menu is displayed, and the unit is off-line.

To select a menu item, press the number on the keypad corresponding to the menu item number.

The functions are described in *Chapter 1* of this reference.

Pressing the F key again resumes communication with the master computer.

Light Grey Keys



**Contrast key
(Half moon symbol)**

The contrast key adjusts the amount of contrast the display uses for viewing purposes. Contrast is adjustable in four steps.

This key is useful for fine tuning the display in unique lighting, temperature, or viewing conditions.

Note: This key is only included with the liquid crystal display (LCD) model of the SOI-260.



**Brightness key
(Sun symbol)**

The brightness key adjusts the amount of LED backlighting on LCD displays, which is adjustable in 4 steps. This key also adjusts the character brightness on VFD displays in 2 steps.

Backlighting is useful if the ambient lighting conditions are not bright enough to allow clear viewing of the display.

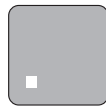

. key
(Decimal point)

Adds a decimal point to the keypad buffer contents.



EXP key

Initiates the process for directly entering ASCII character codes. See “Direct ASCII Code Entry” later in this chapter for more information.



± key
(Change sign)

Adds a “-” (not a “+”) to the keypad buffer contents.



← key
(Backspace)

The backspace key moves the cursor back one position (character) at a time, and deletes the character in the process.

Once you press the ENTER key, the value cannot be deleted with the Backspace key.



White Keys

Adds the corresponding number to the keypad buffer contents.

“Arcade” Entry of ASCII Characters

The arcade entry method uses the PREV/NEXT keys to scroll through a set of ASCII characters. The ENTER key sends the character selected to the keypad buffer. The ENTER key may then be pressed again to set the keypad status to “keys buffered, ready for poll”.

If a character was selected via PREV/NEXT but not entered via ENTER and some other key is pressed, the new key press overrides the Arcade entry.

The following character set is provided:

```
‘ ABCDEFGHIJKLMNOPQRSTUVWXYZ=#?*:%/,,$’
```

The above set includes a space, uppercase A through Z, the equal sign, the pound sign, the question mark, the asterisk, the colon, the percent sign, the forward slash, the comma, and the dollar sign.



Direct ASCII Code Entry

The Direct ASCII code entry method allows the user to press the EXP key followed by a decimal value from 32 through 254 to enter an ASCII code directly. See “Supported Display Characters” in *Chapter 3* for a list of characters and their decimal equivalents.

CHAPTER 5: TROUBLESHOOTING

This chapter of the *Multi-Drop ASCII Communications Reference* provides solutions to possible problems with the SOI-260 and its use with a Multi-Drop RS-485 network. This chapter also contains a description of how to reset your SOI-260.

General Symptoms and Solutions

The most likely problems are improper cabling, invalid commands, and mismatched communication port parameters (baud rate, node address, etc.). The communication parameters must be identical for both the SOI-260 and the network master computer. The cabling and the communications port parameters are always the first things to check.

Note: You can check the communications port parameters either from the SOI or from the SOI-SPS programming software (see “Chapter 1: Configuring”).

If the cabling and communications parameters appear correct, use the “Echo Back Text” command to verify the communications setup.



Resetting Your SOI-260

To reset your SOI-260, press the F key, and then select menu item “4 Reset”. Resetting your SOI-260 forces it to go through a power-up sequence.

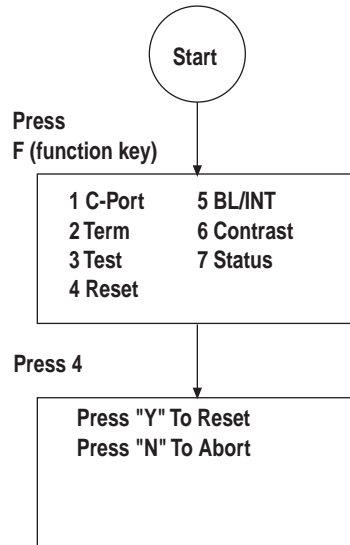

APPENDIX A: EXAMPLE APPLICATION

Read this appendix of the *Multi-Drop ASCII Communications Reference* to become more familiar with how to apply your SOI-260.

The attached Microsoft Quick BASIC source code assumes the use of comm port 2. The SOI-260 is operating in RS-232 mode (point-to-point mode) at node address 1.

This demonstration program displays the following on the SOI-260:

```
Inspect Purge Valve
Enter 1 or 2: _
1-Valve OK
2-Abort
```

The program then polls the SOI-260 for a '1' or '2' and indicates which selection was made.



The following table summarizes the commands used in the attached demonstration program. For the complete command set, see Chapter 3 of this reference.

Command	Parameter List	Comments
F	[0] 0-Turn Alarm LED Off 1-LED On/Flashing	Alarm LED control
o	No Parameters	Clear keypad buffer
p	No parameters	Poll keypad buffer.
?	No Parameters	Request keypad status.
C	No Parameters	Clear Screen.
i	[01][1] 00-20: column 1-4: row	Set cursor position.
x	[01][1][txt] 00-20: column 1-4: row	Set cursor position and write text.

```

ETX$ = CHR$(3)
ESC$ = CHR$(27)
CLS ` Clear screen
`- Initial Master Console COMM Port"
OPEN "com2: 9600,n,8,1,ASC,rs,cs,ds,cd" FOR RANDOM AS #1
`- Global broadcast (all nodes)."
PRINT #1, "00" + ESC$ + "C" + ETX$ `Clear screen
PRINT #1, "00" + ESC$ + "T0" + ETX$ `Set Line termination to option 0 (ETX)
mainLoop:
  CLS ` clear main console screen
WHILE (1) ` Forever loop
  PRINT "Confirm Tank Purge on Operator Station #1"
  `- Create screen on node 1."
  PRINT #1, "01" + ESC$ + "x011" + "Inspect Purge Valve" + ETX$ `Text to column 1 line 1
  PRINT #1, "01" + ESC$ + "x012" + "Enter 1 or 2: _" + ETX$ `Text to column 1 line 2
  PRINT #1, "01" + ESC$ + "x013" + "1-Valve OK" + ETX$ `Text to column 1 line 3
  PRINT #1, "01" + ESC$ + "x014" + "2-Abort" + ETX$ `Text to column 1 line 4

  PRINT #1, "01" + ESC$ + "i152" + ETX$ `Position cur column 15 line 2
  PRINT #1, "01" + ESC$ + "o" + ETX$ `Clear Node 1 key buffer
  PRINT #1, "01" + ESC$ + "F1" + ETX$ `Flash alarm LED

  `- Poll for operator input"
  WHILE (1) ` wait forever
    PRINT #1, "01" + ESC$ + "?" + ETX$ `Request Keypad Status Node 1
    response$ = ""
    temp$ = ""
    WHILE temp$ <> ETX$
      temp$ = INPUT$(1, 1)

```



```

    response$ = response$ + temp$
WEND

IF response$ = "012" + ETX$ THEN ` if key buffer not empty (Node1)
PRINT #1, "01" + ESC$ + "p" + ETX$ `Request Keypad Status Node 1
    response$ = ""
    temp$ = ""
    WHILE temp$ <> ETX$
        temp$ = INPUT$(1, 1)
        response$ = response$ + temp$
    WEND
PRINT "Poll key response$= " + response$
PRINT #1, "01" + ESC$ + "C" + ETX$ `Clear screen node 1

    IF response$ = "01" + ETX$ THEN
        scrn$ = "Purging tank ..."
    ELSE
        scrn$ = "Aborting Purge ..."
    END IF
PRINT "Station #1 " + scrn$
PRINT #1, "01" + ESC$ + "x011" + scrn$ + ETX$ `Text to node 1 column 1 line 1
GOTO continueMain
END IF
WEND
continueMain:
PRINT #1, "01" + ESC$ + "F0" + ETX$ `Flash alarm LED off
PRINT
PRINT "Select one of the following:"
PRINT " 1-Continue procedure"
PRINT " 2-Abort procedure"
WHILE (1)
    key$ = INKEY$
    IF key$ = "2" THEN END ` break forever loop
    IF key$ = "1" THEN GOTO mainLoop
WEND
WEND ` End main forever loop
CLOSE #1
END ` End program

```



INDEX

SYMBOLS

← key 35
*.cfg files 6, 7, 9
. key 35
± key 35

A

Adapters 2
Addressing 8, 11, 15–16, 17, 37
Alarm LED 19
Anti-static material ii
Application programs, uploading/downloading 6, 7–9
Arcade entry 35
ASCII
 code entry 36
 display characters 24–26

B

Backspace key 35
Baud rate 8, 11, 37
Blinking
 cursor 8
 LED 19
Block cursor 8, 11
Brightness key 34
Broadcasting 16
Buffer 2, 20
Bus contention 16

C

Cabling 13–14, 37
CE key 33
Change sign key 35
Clear

 entry 33
 screen 21
Column number 22, 23
Command 16–23
 data 16
 response 8, 11
 terminator 15–16
Communication
 cabling 13–14
 port parameters 37
 ports 1, 6, 8, 11, 13–14
Computer 1. *See also* Programming computer. *See*
 Network master computer
Configuring 5–11, 17–19
Connectors 13
Contrast key 34
Control codes 26–27
Controller 1. *See* Network master computer
Cursor
 configuring 8, 11
 position 22, 23

D

Data bits 8, 11
Data entry 31–36, 39
Data link 13
Decimal ASCII codes 24–26
Decimal point key 35
DIP switch 5–7
Display 21–23
 characters 24–26
 configuring 8, 11
Documentation 3
Downloading/uploading applications 6, 7–9



E

Echo 8, 11, 18, 19, 37
Electrostatic damage ii
Enter key 33
Entering data 31–36, 39
Entry echo 8, 11
ESC 16
ESD ii
ETX 15–16
EXP key 35

F

F key 6, 9–11, 34
Flashing alarm LED 19
Flashing block cursor 8, 11
Function key. *See* F key

G

Global broadcast 16
Ground 14

H

Half moon symbol 34
Hex ASCII codes 24–26
Host controller 1. *See* Network master computer

I

ID 8, 11, 16, 17, 37
Illegal command 16, 26–27, 37
Incomplete command 16, 26–27
Installation 13

K

Keypad
 buffer 2, 20
 commands 19–21
 enabling/disabling 8, 11
 entry 31–35
 status 21
Keys
 green 32–34
 light grey 34–36
 white 35

L

LED 19
Liability i
Line number 22, 23
Line terminator 8, 11

M

MAIN MENU key 32
Master computer 1, 11
Master Security Enable 6
Messages 16–23
Multi-drop network 6, 13

N

N key 33
Network 13
Network master computer 11
NEXT key 33
Node address 8, 11, 15–16, 17, 37

O

ø key 33
OS 6

P

Packaging ii
Parity 8, 11
Personal computer 1. *See also* Programming computer. *See* Network master computer
Pin connections 13–14
Point-to-point communications 4, 39
Polling 20, 39
Ports 6, 8, 11, 13–14
PREV key 33
PREV MENU key 32
Programming computer 1, 7
Programming software 7–9
Programs, uploading/downloading 6, 7–9
Protocol 16–23
Publications 3

R

Repackaging ii
Resetting 38
Resistor termination 14
Response terminator 11, 17
Return key 33
Row number 22, 23
RS-232 4, 6, 39
RS-485 6, 13

S

Screen. *See* Display
Setting up 5–11, 13–14
Shield 14
SOI-SPS 7–9



Static charge ii
Status, keypad 21
STX 15–16, 16
Sun symbol key 34
Switches 5–7
Syntax 16

T

Terminal mode 3, 6
Terminataion 14
Terminator
 command 15–16, 16
 response 8, 11, 17
Troubleshooting 37–38

U

Underlined cursor 8, 11
Unsupported control codes 26–27
Uploading/downloading applications 6, 7–9

W

Warranty i
Writing text 22, 39

Y

Y Key 33



Copyright © 1998 Spectrum Controls, Inc. All rights reserved.
Specifications subject to change without notice. Printed in U.S.A.
Publication 0300155-02 Rev. B April 1998

Corporate Headquarters

Spectrum Controls, Inc.
P.O. Box 5533 • Bellevue, Washington 98006
Fax: (425) 641-9473 • Tel: (425) 746-9481

Northeastern U.S.A. Sales Office

Spectrum Controls, Inc.
48945 Van Dyke, 4B • Utica, Michigan 48317
Fax: (586) 731-2715 • Tel: (586) 731-2397

Southeastern U.S.A. Sales Office

Spectrum Controls, Inc.
8860 Saddle Trail • Ball Ground, Georgia 30107
Fax: (678) 455-4615 • Tel: (678) 455-4640

Web Site: <http://www.spectrumcontrols.com>
E-mail: spectrum@spectrumcontrols.com

