

Owner's Guide 0300199-01 Rev. B

CONTROLLOGIX™ COUNTER MODULE

Catalog Number: 1756sc-CTR8



Important Notes

1. Please read all the information in this owner's guide before installing the product.
2. The information in this owner's guide applies to hardware version A and firmware version 2.0 or later.
3. This guide assumes that the reader has a full working knowledge of the relevant processor.

Notice

The products and services described in this owner's guide are useful in a wide variety of applications. Therefore, the user and others responsible for applying the products and services described herein are responsible for determining their acceptability for each application. While efforts have been made to provide accurate information within this owner's guide, Spectrum Controls assumes no responsibility for the accuracy, completeness, or usefulness of the information herein.

Under no circumstances will Spectrum Controls be responsible or liable for any damages or losses, including indirect or consequential damages or losses, arising out of either the use of any information within this owner's guide or the use of any product or service referenced herein.

No patent liability is assumed by Spectrum Controls with respect to the use of any of the information, products, circuits, programming, or services referenced herein.

The information in this owner's guide is subject to change without notice.

Limited Warranty

Spectrum Controls warrants that its products are free from defects in material and workmanship under normal use and service, as described in Spectrum Controls literature covering this product, for a period of 1 year. The obligations of Spectrum Controls under this warranty are limited to replacing or repairing, at its option, at its factory or facility, any product which shall, in the applicable period after shipment, be returned to the Spectrum Controls facility, transportation charges prepaid, and which after examination is determined, to the satisfaction of Spectrum Controls, to be thus defective.

This warranty shall not apply to any such equipment which shall have been repaired or altered except by Spectrum Controls or which shall have been subject to misuse, neglect, or accident. In no case shall the liability of Spectrum Controls exceed the purchase price. The aforementioned provisions do not extend the original warranty period of any product which has either been repaired or replaced by Spectrum Controls.

Preface

Read this preface to familiarize yourself with the rest of the owner's guide. This preface covers:

- who should use this guide
- what this guide covers
- related Allen-Bradley documents
- terms & abbreviations you should know

Who Should Use This Guide

Use this guide if you design, install, program, or maintain a control system that uses Allen-Bradley ControlLogix Controllers.

You should have a basic understanding of ControlLogix products. You should also understand electronic process control and the ladder program instructions required to generate the electronic signals that control your application. If you do not, contact your local Allen-Bradley representative for the proper training before using these products.

What This Guide Covers

This guide covers the 1756sc-CTR8 counter/flow module. It contains the information you need to install, wire, use, and maintain these modules. It also provides diagnostic and troubleshooting help should the need arise.

Related Allen-Bradley Documents

Table A lists several Allen-Bradley documents that may help you as you use these products.

Table A. Related Allen-Bradley documents

Allen-Bradley Doc. No.	Title	Publication Number
1756-PA72, -PB72	ControlLogix Power Supply Installation Instructions	1756-5.1
1756-A4, -A7, -A10, -A13, -A17	ControlLogix Chassis Installation Instructions	1756-5.2

1756 Series ControlLogix Module Installation Instructions (Each module has separate document for installation)	1756-5.5, -5.42
1756-L1, Logix5550 Controller User Manual -L1M1, -L1M2	1756-6.5.12
1756-DHRIO ControlLogix Data Highway Plus Communication Interface Module User Manual	1756-6.5.2
1756-ENET ControlLogix Ethernet Communication Interface Module User Manual	1756-6.5.1

To obtain a copy of any of the Allen-Bradley documents listed, contact your local Allen-Bradley office or distributor.

Terms & Abbreviations You Should Know

You should understand the following terms and abbreviations before using this guide.

A/C - Refers to alternating current. This is a sine wave signal that is typically associated with magnetic pickup flowmeters.

Attenuation – The reduction in magnitude of a signal as it passes through a system. The opposite of gain.

Channel – Refers to one of eight, small-signal analog input interfaces to the module's terminal block. Each channel is configured for connection to an input device, and has its own configuration and status words.

Chassis – See rack.

Common mode rejection ratio (CMRR) - The ratio of a device's differential voltage gain to common mode voltage gain. Expressed in dB, CMRR is a comparative measure of a device's ability to reject interference caused by a voltage common to its terminal relative to ground.

Common mode voltage – The voltage difference between the negative terminal and analog common during normal differential operation.

Cut-off frequency - The frequency at which the input signal is attenuated 3 dB by the digital filter. Frequency components of the input signal that are below the cut-off frequency are passed with under 3 dB of attenuation for low-pass filters.

DC - Direct Current - This is typically associated with a DC square-wave pulse signal from a flowmeter.

dB (decibel) – A logarithmic measure of the ratio of two signal levels.

Digital filter - A low-pass mathematic single order filter applied to the signal. The digital filter provides high-frequency noise rejection.

Effective resolution – The number of bits in the channel data word that do not vary due to noise.

Local System - A control system with I/O chassis within several feet of the processor.

LSB (least significant bit) – The bit that represents the smallest value within a string of bits.

Normal mode rejection (differential mode rejection) – A logarithmic measure, in dB, of a device's ability to reject noise signals between or among circuit signal conductors, but not between the equipment grounding conductor or signal reference structure and the signal conductors.

Module update time – See channel update time.

Remote system - A control system where the chassis can be located several thousand feet from the processor chassis. Chassis communication is via the 1756-DHRIO and 1756-ENET Adapter.

Resolution – The smallest detectable change in a measurement, typically expressed in engineering units (e.g. 0.15 °C).

Sampling time - The time required by the module to sample an input channel.

Step response time – The time required for the module to reach 95% of its expected, final value, given a full-scale step change in the output data word.

Tags - Identifiers for configuration, data, and status information found within the module. Tags allow the user to modify specific module attributes and view data and status.

Update time – The time for the module to sample and convert a channel input signal and make the resulting value available to the ControlLogix processor.

Table of Contents

Preface	v	Who Should Use This Guide	v
		What This Guide Covers	v
		Related Allen-Bradley Documents	v
		Table A. Related Allen-Bradley documents	v
		Terms & Abbreviations You Should Know	vi
Chapter 1			
Module Overview		General Description	1
		Table 1.1 Hardware Features	2
		System Overview	2
		Cables	3
		Installing And Wiring Your Module	1
		Electrostatic Damage	1
Chapter 2			
Installing Your		Power Requirements	2
Module		Module Installation and Removal	2
		Wiring Your Module	6
		Wiring Single-ended Inputs	7
		Wiring Bi-Directional or Quadrature Inputs	8
Chapter 3			
Operation in the		Operation Within the	
System		ControlLogix System	17
		Ownership and Connections	17
		Using RSNetWorx and RSLogix 5000	17
		Direct Connections	18
		Module Operation	18
		Modules in a Local Chassis	18
		Requested Packet Interval (RPI)	19
		Modules in a Remote Chassis	19
		Listen-Only Mode	20
		Multiple Owners of Input Modules	20
		Configuration Changes in an Input Module with Multiple Owners	21
Chapter 4			
Programming Your		Module Installation	23
Module		Adding Your Module to a Project	23

Chapter 5 Configuring module attributes:

Configuration, Data, and Status Tags	31
Send Configuration Data to the Module	31
Configuration Tags	32
Channel Specific Settings	32
Output Tags	37
Input Tags	37

Chapter 6 Programming Examples

Initial Programming	39
Figure 5.1 Sample Ladder Logic	40
Using the gate storage mode	42
Installation Recommendations	44
Meter Proving	45

Chapter 7 Troubleshooting

Using Module Indicators to Troubleshoot	45
Using RSLogix 5000 to Troubleshoot Your Module	46
Module Configuration Errors	47

Chapter 8 Maintaining Your Module

Preventive Maintenance	49
Safety Considerations	49

Appendix A Module Specifications

Electrical Specifications	53
Environmental Specifications	54
Input Specifications	54
Accuracy	54

Appendix B Programming Your Module

Module Installation	57
Adding Your Module to a Project	57
Declaration of Conformity	64

Module Overview

This chapter describes the counter module and explains how the ControlLogix controller reads analog input data from the module. Read this chapter to familiarize yourself further with your counter module. This chapter covers:

- general description and hardware features
- an overview of system and module operation

General Description

This module is designed exclusively for use in the Allen-Bradley ControlLogix 1756 I/O rack systems. The module reads AC and DC pulse information from external sensors and stores it in its image table for retrieval by all ControlLogix processors.

Following is a list of features available on the CTR8 module that allow their use in a wide variety of applications.

- Removal and insertion under power (RIUP) - a system feature that allows you to remove and insert modules while chassis power is applied
- Producer/consumer communications - an intelligent data exchange between modules and other system devices in which each module produces data without having been polled
- System timestamp of data - 64 bit system clock places a timestamp on the transfer of data between the module and its owner controller within the local chassis
- IEEE 32 bit floating point format
- On-Board Features, such as custom User Scaling, Analog and Digital Filtering, and Under/Over Detection
- Class I/Division 2, UL, CUL, CE, and FM Agency Certification

Input Types

The 1756-CTR supports both AC and DC input signal types. The module input type is configured on a channel pair basis. Each pair must be configured for the same input type.

Hardware Features

The module fits into any single slot for I/O modules in a ControlLogix modular system. The module has a unique generic profile which may be configured using your RSLogix 5000 programming software.

The module utilizes one removable terminal block, that provides connections for the eight input channels. The module is configured through RSLogix 5000 software, defining input type, counter control and signal filtering.

Table 1.1 Hardware Features

Hardware	Function
OKLED	Displays communication and fault status of the module
SYSDLED	Displays a fault condition
Side Label (Nameplate)	Provides module information
Removable Terminal Block	Provides electrical connection to input devices
Door Label	Permits easy terminal identification
Self Locking Tabs	Secure module in chassis slot
Terminal Block Switch	Locks the RTB to the module.

Diagnostic LEDs

The module contains diagnostic LEDs that help you identify the source of problems that may occur during power-up or during normal operation. Power-up and diagnostics are explained in Chapter 7, *Testing Your Module*.

System Overview

The module communicates with the ControlLogix processor and receives +5 Vdc and +24 Vdc power from the system power supply through the parallel backplane interface. You may install as many counter modules in the system as the power supply can support.

Channels (0 through 7) can receive AC or DC input signals. Input types must be configured in channel pairs. Each channel reports both count data and rate data in independent registers. Extended status information is also available for each channel.

System Operation

At power-up, the module checks internal circuits, memory, and basic functions. During this time the SYS LED remains on. If the module does not find any faults, it turns off the SYS LED.

After completing power-up checks, the module wait for a connection to an owner controller then valid channel configuration data from your ladder logic program. After channel configuration data is transferred, and one or more channels are enabled, the module continuously converts the inputs to floating point data for use in your ladder program.

Each time the module reads an input channel, the module tests that data for a fault, i.e. signal mismatch, or out of range condition. If it detects an error condition, the module sets a unique bit in the status tags.

Module Operation

The module's input circuitry consists of eight single-ended inputs, routed into an FPGA. The FPGA reads the input signals and converts them to counter and rate and then presents them in floating point values.. The input circuitry also supports gate inputs allowing you to disable and control counter operation.

Cables

Cable length should be kept to a minimum. Use the lowest capacitance shielded cable available. We recommend that you use *Belden #9501 (or equivalent)*.

Table 1.2 Cable Specifications

Description	Belden #9501
When used?	AC/DC inputs.
Conductors	2, #24AWG tinned copper (7x32)
Shield	Beldfoil aluminum polyester shield w/ copper drain wire.
Insulation	PVC
Jacket	Chrome PVC
Agency Approval	NEC Type CM
Temperature Rating	80°C

Installing And Wiring Your Module

Read this chapter to install and wire your module. This chapter covers:

- avoiding electrostatic damage
- determining power requirements
- installing the module
- wiring signal cables to the module's terminal block

Electrostatic Damage

Electrostatic discharge can damage semiconductor devices inside this module if you touch backplane connector pins. Guard against electrostatic damage by observing the following precautions:

CAUTION

ELECTROSTATICALLY SENSITIVE COMPONENTS

- Before handling the module, touch a grounded object to rid yourself of electrostatic charge.
- When handling the module, wear an approved wrist strap grounding device.
- Handle the module from the front, away from the backplane connector. Do not touch backplane connector pins.
- Keep the module in its static-shield container when not in use or during shipment.

Failure to observe these precautions can degrade the module's performance or cause permanent damage.

Power Requirements

The module receives its power through the ControlLogix chassis backplane from the fixed or modular +5 VDC and +24 VDC chassis power supply. The maximum current drawn by the module is shown in the table below.

Table 2.1. Maximum current drawn by the module

5VDC Amps	24VDC Amps
0.230	0.075

Using your module in the ControlLogix System

Place your module in any slot of a ControlLogix modular, or modular expansion chassis.

An analog I/O module translates an analog signal into, or from, a corresponding digital representation which controllers can easily operate on for control purposes.

A ControlLogix I/O module mounts in a ControlLogix chassis and uses a Removable Terminal Block (RTB) to connect all field-side wiring.

Before you install and use your module you should have already:

- installed and grounded a 1756 chassis and power supply.
- ordered and received an RTB for your application.

Important: RTBs are not included with your module purchase.

Specify Allen Bradley Part Number:

1756-TBCH - 36 position screw terminals

1756-TBS6H - 36 position press terminals

Module Installation and Removal

When installing the module in a chassis, it is not necessary to remove the terminal blocks from the module. However, if the terminal blocks are removed, use the write-on label located on the side of the terminal blocks to identify the module location and type.

Preventing Electrostatic Discharge

This module is sensitive to electrostatic discharge.

ATTENTION: Electrostatic discharge can damage integrated circuits or semiconductors if you touch backplane connector pins. Follow these guidelines when you handle the module:

- Touch a grounded object to discharge static potential
 - Wear an approved wrist-strap grounding device
 - Do not touch the backplane connector or connector pins
 - Do not touch circuit components inside the module
 - If available, use a static-safe work station
 - When not in use, keep the module in its static-shield box
-

Removal and Insertion Under Power

These modules are designed to be installed or removed while chassis power is applied.

ATTENTION: When you insert or remove a module while backplane power is applied, an electrical arc may occur. An electrical arc can cause personal injury or property damage by:

- sending an erroneous signal to your system's field devices causing unintended machine motion or loss of process control.
- causing an explosion in a hazardous environment.

Repeated electrical arcing causes excessive wear to contacts on both the module and its mating connectors. Worn contacts may create electrical resistance that can affect module operation.

Compliance to European Union Directives

If this product bears the CE marking, it is approved for installation within the European Union and EEA regions. It has been designed and tested to meet the following directives.

EMC Directive

This product is tested to meet Council Directive 89/336/EEC Electromagnetic Compatibility (EMC) and the following standards, in whole or in part, documented in a technical construction file:

EN 61010-1 and EN 61131-2, EN61000-6-2:2001, EN61000-6-4:2001
EN61010-1:2001

This product is intended for use in an industrial environment.

Low Voltage Directive

This product is tested to meet Council Directive 73/23/EEC Low Voltage, by applying the safety requirements of EN 61131-2 Programmable Controllers, Part 2 - Equipment Requirements and Tests.

For specific information required by , EN61131-2:1994 + A11:1996 + A12:2000, see the appropriate sections in this publication, as well as the following Allen-Bradley publications:

- Industrial Automation Wiring and Grounding Guidelines For Noise Immunity, publication 1770-4.1
- Automation Systems Catalog, publication B111

This equipment is classified as open equipment and must be installed (mounted) in an enclosure during operation as a means of providing safety protection.

CAUTION

POSSIBLE EQUIPMENT OPERATION

ATTENTION: The module is designed to support Removal and Insertion Under Power (RIUP). However, when you remove or insert an RTB with field-side power applied, **unintended machine motion or loss of process control can occur**. Exercise extreme caution when using this feature.

ATTENTION: Counter input isolated secondary circuits must be energy limited and limited to not source more than 5.8 amp into either the Counter inputs or the Gate inputs in the event of a component failure

WARNING

The 1756sc-CTR8 module is to be used only with the Allen-Bradley 1756 ControlLogix System.

To insert your module into the rack, follow these steps:

1. Align the circuit board of your module with the card guides at the top and bottom of the chassis.

Figure 2.1. Module insertion into a rack

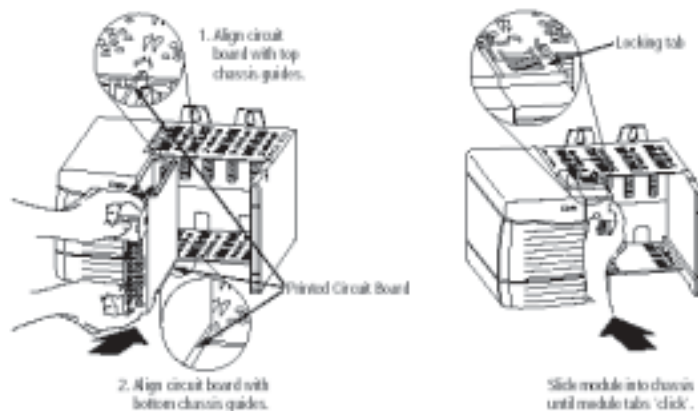

2. Key the RTB in positions that correspond to unkeyed module positions. Insert the wedge-shaped tab on the RTB with the rounded edge first. Push the tab onto the RTB until it stops.

Keying the Removable Terminal Block

Key the RTB to prevent inadvertently connecting the incorrect RTB to your module.

When the RTB mounts onto the module, keying positions will match up. For example, if you place a U-shaped keying band in position #4 on the module, you cannot place a wedge-shaped tab in #4 on the RTB or your RTB will not mount on the module.

We recommend that you use a unique keying pattern for each slot in the chassis.

1. Insert the U-shaped band with the longer side near the terminals. Push the band onto the module until it snaps into place.

Figure 2.2. Terminal block diagram with keying

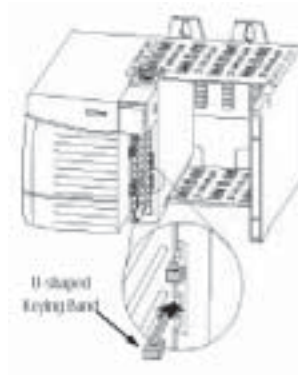

Wiring Your Module

Follow these guidelines to wire your input signal cables:

- Power, input, and output (I/O) wiring must be in accordance with Class 1, Division 2 wiring methods [Article 501-4(b) of the National Electrical Code, NFPA 70] and in accordance with the authority having jurisdiction.
- Peripheral equipment must be suitable for the location in which it is used.
- Route the field wiring away from any other wiring and as far as possible from sources of electrical noise, such as motors, transformers, contactors, and ac devices. As a general rule, allow at least 6 in. (about 15.2 cm) of separation for every 120 V of power.
- Routing the field wiring in a grounded conduit can reduce electrical noise further.

- If the field wiring must cross ac or power cables, ensure that they cross at right angles.
- To limit the pickup of electrical noise, keep signal wires as far from power and load lines as possible.
- Ground the shield drain wire at only one end of the cable. The preferred location is at the shield connections at the ControlLogix chassis. (Refer to IEEE Std. 518, Section 6.4.2.7 or contact your sensor manufacturer for additional details.)
- Tighten screw terminals with care. Excessive tightening can strip a screw.
- Follow system grounding and wiring guidelines found in your ControlLogix Installation and Operation Manual.

Preparing and Wiring the Cables

To prepare and connect cable leads and drain wires, follow these steps:

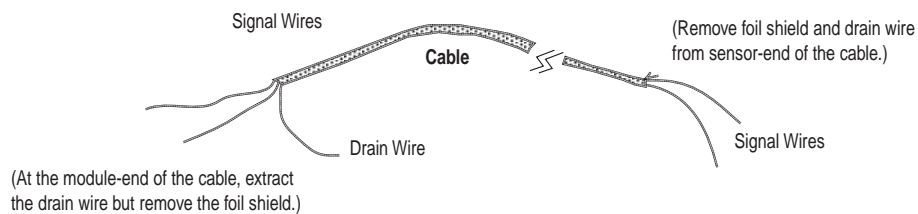

1. At each end of the cable, strip some casing to expose individual wires.
2. Trim signal wires to 5-inch lengths beyond the cable casing. Strip about 3/16 inch (4.76 mm) of insulation to expose the ends of the wires.
3. At the module-end of the cables (see figure above):
 - extract the drain wire and signal wires
 - remove the foil shield
 - bundle the input cables with a cable strap
4. Connect pairs of drain wires together, Channels 0 and 1, Channels 2 and 3, Channels 4 and 5, Channels 6 and 7. Keep drain wires as short as possible.
5. Connect the drain wires to the grounding lug on the PLC chassis.
6. Connect the signal wires of each channel to the terminal block. Important: Only after verifying that your connections are correct for each channel, trim the lengths to keep them short. Avoid cutting leads too short.
7. At the source-end of cables from devices:
 - remove the drain wire and foil shield
 - apply shrink wrap as an option
 - connect to mV devices keeping the leads short

Important: If noise persists, try grounding the opposite end of the cable, instead (Ground one end only.)

Wiring Single-ended Inputs

The following figure shows the general terminal block layout. A single-ended input uses a pair of terminals, Hi(x) and Com. Gate lines are wired with their respective Gate(x) and Com terminals.

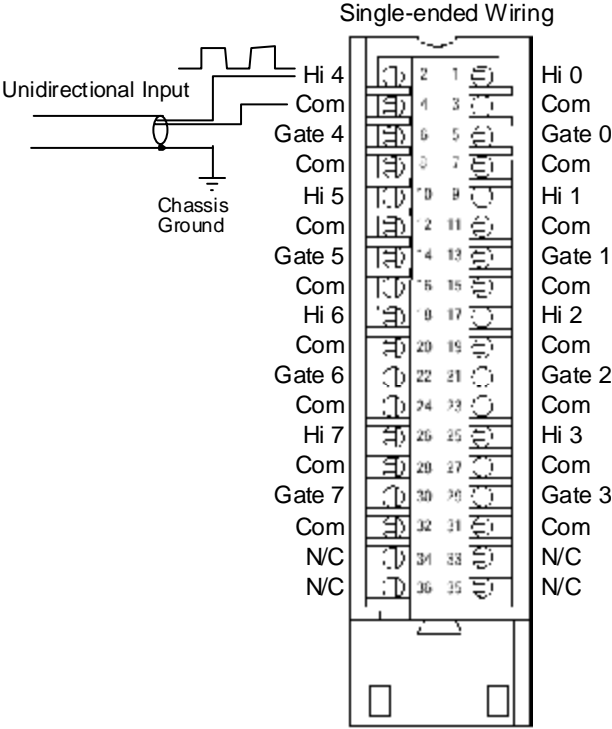

Wiring Bi-Directional or Quadrature Inputs

Input use channel pairs, for example Hi2(A), Com, Hi2(B), Com. There is one gate input per channel pair.

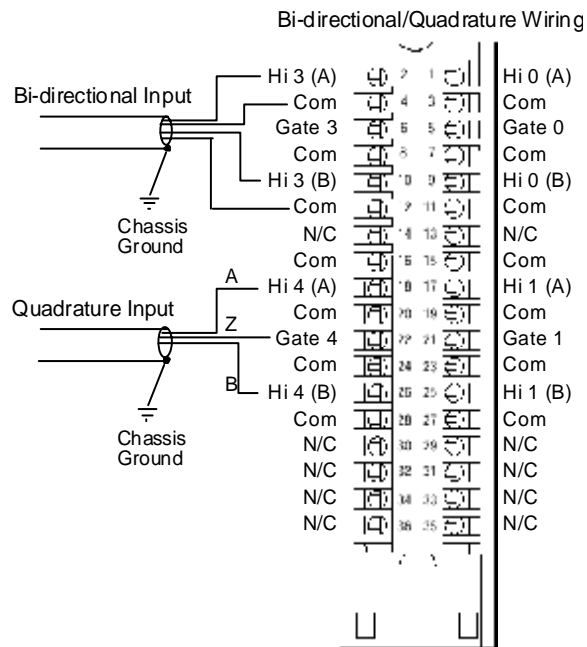

Operation Within the ControlLogix System

This chapter describes how the 1756sc-CTR8 analog module works within the ControlLogix system. This chapter covers:

- Ownership and connections to the module
- Direct connections
- Listen only mode
- Configuration changes with multiple owners.

Ownership and Connections

Every I/O module in the ControlLogix system must be owned by a Logix5550 Controller to be useful. This owner-controller stores configuration data for every module that it owns and can be local or remote in regard to the I/O module's position. The owner sends the I/O module configuration data to define the module's behavior and begin operation within the control system. Each ControlLogix I/O module must continuously maintain communication with its owner to operate normally.

Typically, each module in the system will have only 1 owner. Input modules can have more than 1 owner. Output modules, however, are limited to a single owner.

Using RSNetWorx and RSLogix 5000

The I/O configuration portion of RSLogix5000 generates the configuration data for each I/O module in the control system, whether the module is located in a local or remote chassis. A remote chassis, also known as networked, contains the I/O module but not the module's owner controller. Configuration data is transferred to the controller during the program download and subsequently transferred to the appropriate I/O modules. I/O modules in the same chassis as the controller are ready to run as soon as the configuration data has been downloaded. You must run RSNetWorx to enable I/O modules in the networked chassis.

Running RSNetWorx transfers configuration data to networked modules and establishes a Network Update Time (NUT) for ControlNet that is compliant with the desired communications options specified for each module during configuration. If you are not using I/O modules in a networked chassis, running RSNetWorx is not necessary. However, anytime a controller references an I/O module in a networked chassis, RSNetWorx must be run to configure ControlNet. Follow these general guidelines when configuring I/O modules:

1. Configure all I/O modules for a given controller using RSLogix 5000 and download that information to the controller.
2. If the I/O configuration data references a module in a remote chassis, run RSNetWorx.

Important: RSNetWorx **must** be run whenever a new module is added to a networked chassis. When a module is permanently removed from a remote chassis, we recommend that RSNetWorx be run to optimize the allocation of network bandwidth.

Direct Connections

A **direct connection** is a real-time data transfer link between the controller and the device that occupies the slot that the configuration data references. When module configuration data is downloaded to an owner-controller, the controller attempts to establish a direct connection to each of the modules referenced by the data.

If a controller has configuration data referencing a slot in the control system, the controller periodically checks for the presence of a device there. When a device's presence is detected, the controller automatically sends the configuration data. If the data is appropriate to the module found in the slot, a connection is made and operation begins. If the configuration data is not appropriate, the data is rejected and an error message displays in the software. In this case, the configuration data can be inappropriate for any of a number of reasons.

The controller maintains and monitors its connection with a module. Any break in the connection, such as removal of the module from the chassis while under power, causes the controller to set fault status bits in the data area associated with the module. The RSLogix 5000 software may monitor this data area to announce the modules' failures.

Module Operation

In traditional I/O systems, controllers poll input modules to obtain their input status. Analog input modules in the ControlLogix system are not polled by a controller once a connection is established. The modules multicast their data periodically. Multicast frequency depends on the options chosen during configuration and where in the control system that input module physically resides. An input module's communication, or multicasting, behavior varies depending upon whether it operates in the local chassis or in a remote chassis. The following sections detail the differences in data transfers between these set-ups.

Modules in a Local Chassis

When a module resides in the same chassis as the owner controller, the following two configuration parameters will affect how and when the input module multicasts data:

- Real Time Sample (RTS) configured via Real Time Sample tag.
- Requested Packet Interval (RPI) configured via I/O module properties.

Real Time Sample (RTS)

This configurable parameter instructs the module to perform the following operations:

1. **scan all** of its input channels and store the data into on-board memory
2. multicast the updated channel data (as well as other status data) to the backplane of the local chassis

Requested Packet Interval (RPI)

This configurable parameter also instructs the module to multicast its channel and status data to the local chassis backplane.

The RPI instructs the module to multicast the **current contents** of its on-board memory when the RPI expires, (i.e. the module does not update its channels prior to the multicast).

Important: The RPI value is set during the initial module configuration using RSLogix 5000.

It is important to note that the module will reset the RPI timer each time an RTS is performed. This operation dictates how and when the owner controller in the local chassis will receive updated channel data, depending on the values given to these parameters. If the RTS value is less than or equal to the RPI, each multicast of data from the module will have updated channel information. In effect, the module is only multicasting at the RTS rate.

If the RTS value is greater than the RPI, the module will multicast at both the RTS rate and the RPI rate. Their respective values will dictate how often the owner controller will receive data and how many multicasts from the module contain updated channel data. Note: Even though data may be transferred at the RPI rate, the data will be identical to the previous RTS data transfer.

Modules in a Remote Chassis

If an input module resides in a networked chassis, the role of the RPI and the module's RTS behavior change slightly with respect to getting data to the owner. The RPI and RTS intervals still define when the module will multicast data **within its own chassis** (as described in the previous section), but only the value of the RPI determines how often the owner controller will receive it over the network.

When an RPI value is specified for an input module in a remote chassis, in addition to instructing the module to multicast data within its own chassis, the RPI also "reserves" a spot in the stream of data flowing across the ControlNet network.

The timing of this “reserved” spot may or may not coincide with the exact value of the RPI, but the control system will guarantee that the owner controller will receive data **at least as often** as the specified RPI.

The “reserved” spot on the network and the module’s RTS are asynchronous to each other. This means there are Best and Worst Case scenarios as to when the owner controller will receive updated channel data from the module in a networked chassis.

Best Case RTS Scenario

In the Best Case scenario, the module performs an RTS multicast with updated channel data just before the “reserved” network slot is made available. In this case, the remotely located owner receives the data almost immediately.

Worst Case RTS Scenario

In the Worst Case scenario, the module performs an RTS multicast just after the “reserved” network slot has passed. In this case, the owner-controller will not receive data until the next scheduled network slot.

Because it is the RPI and NOT the RTS which dictates when the module’s data will be sent over the network, we recommend the RPI value be set LESS THAN OR EQUAL TO the RTS to make sure that updated channel data is received by the owner controller with each receipt of data.

Listen-Only Mode

Any controller in the system can **listen** to the data from any I/O module (e.g. input data or “echoed” output data) even if the controller does not own the module (i.e. it does not have to hold the module’s configuration data to listen to the module).

The “listen only” mode is set during the I/O configuration process.

Choosing a ‘Listen-Only’ mode option allows the controller and module to establish communications without the controller sending any configuration data. In this instance, another controller owns the module being listened to.

Important: Controllers using the Listen-Only mode continue to receive data multicast from the I/O module as long as a connection between an owner and I/O module is maintained. If the connection between all owners and the module is broken, the module stops multicasting data and connections to all ‘Listening controllers’ are also broken.

Multiple Owners of Input Modules

Because ‘Listening controllers’ lose their connections to modules when communications with the owner stop, the ControlLogix system will allow you to define more than one owner for input modules.

Important: Only input modules can have multiple owners. If multiple owners are connected to the same input module, they **must maintain identical configuration** for that module.

In the example below, Controller A and Controller B have both been configured to be the owner of the input module.

When the controllers begin downloading configuration data, both try to establish a connection with the input module. Whichever controller's data arrives first establishes a connection. When the second controller's data arrives, the module compares it to its current configuration data (the data received and accepted from the first controller).

If the configuration data sent by the second controller matches the configuration data sent by the first controller the connection is also accepted. If any parameter of the second configuration data is different from the first, the module rejects the connection and the user is informed by an error in the software.

The advantage of multiple owners over a 'Listen-only' connection is that now either of the controllers can lose the connection to the module and the module will continue to operate and multicast data to the system because of the connection maintained by the other owner controller.

Note: The previous discussion of multiple owners assumes the configuration tag ".configrevnumber" is set to 1. Operation differs if the tag is set to 0. Refer to Chapter 5 for descriptions of this tag's settings.

Configuration Changes in an Input Module with Multiple Owners

You must be careful when changing an input module's configuration data in a multiple owner scenario. When the configuration data is changed in one of the owners, for example, Controller A, and sent to the module, that configuration data is accepted as the new configuration for the module. Controller B will continue to listen, unaware that any changes have been made in the module's behavior.

Important: When changing configuration for a module with multiple owners, we recommend the connection be inhibited. To prevent other owners from receiving potentially erroneous data, as described above, the following steps **must be followed** when changing a module's configuration in a multiple owner scenario when online:

1. For each owner controller, inhibit the controller's connection to the module in the software on the I/O Module Connection tab.
2. Make the appropriate configuration data changes in the software.

Programming Your Module

This chapter explains how to program your module in the ControlLogix system. It also describes how the module's input configuration are incorporated into your ladder logic program. Topics discussed include:

- importing the module's configuration profile
- reviewing accessing and altering configuration options.
- configuring the modules input type and filter settings
- configuring alarms and limits

Module Installation

Incorporating your module into the system is similar to adding any type of I/O module. You will use your RSLogix 5000 programming software. The module is not currently in the pick list of this software so you will drag and drop sample information from a sample program. This allows you to import the configuration database into your project and set the attributes of each tag. These settings control features such as the modules input type, channel input range, data format, filter frequency, etc.

You will need to download the sample project from our website and then import this into your project. Then you may access the controller tags to configure the module once this process is complete.

Adding Your Module to a Project

The module has a unique set of tag definitions which are used to configure specific features. Chapter 5, *Channel Configuration, Data, and Status*, gives you detailed information about the data content of the configuration. These values are set using your programming software and ladder logic. Before you can use these feature you must first include the module into the project.

Step 1- Open the sample project with the CTR8 information. Open your project. Drag and drop the CTR8 module into the I/O configuration section of your project.

1. Open the sample project.
2. Open your new project.
3. Click once on the CTR8 in the sample project.
4. Drag and drop it into the I/O Configuration section of your project.

See Appendix D for the I/O module property details.

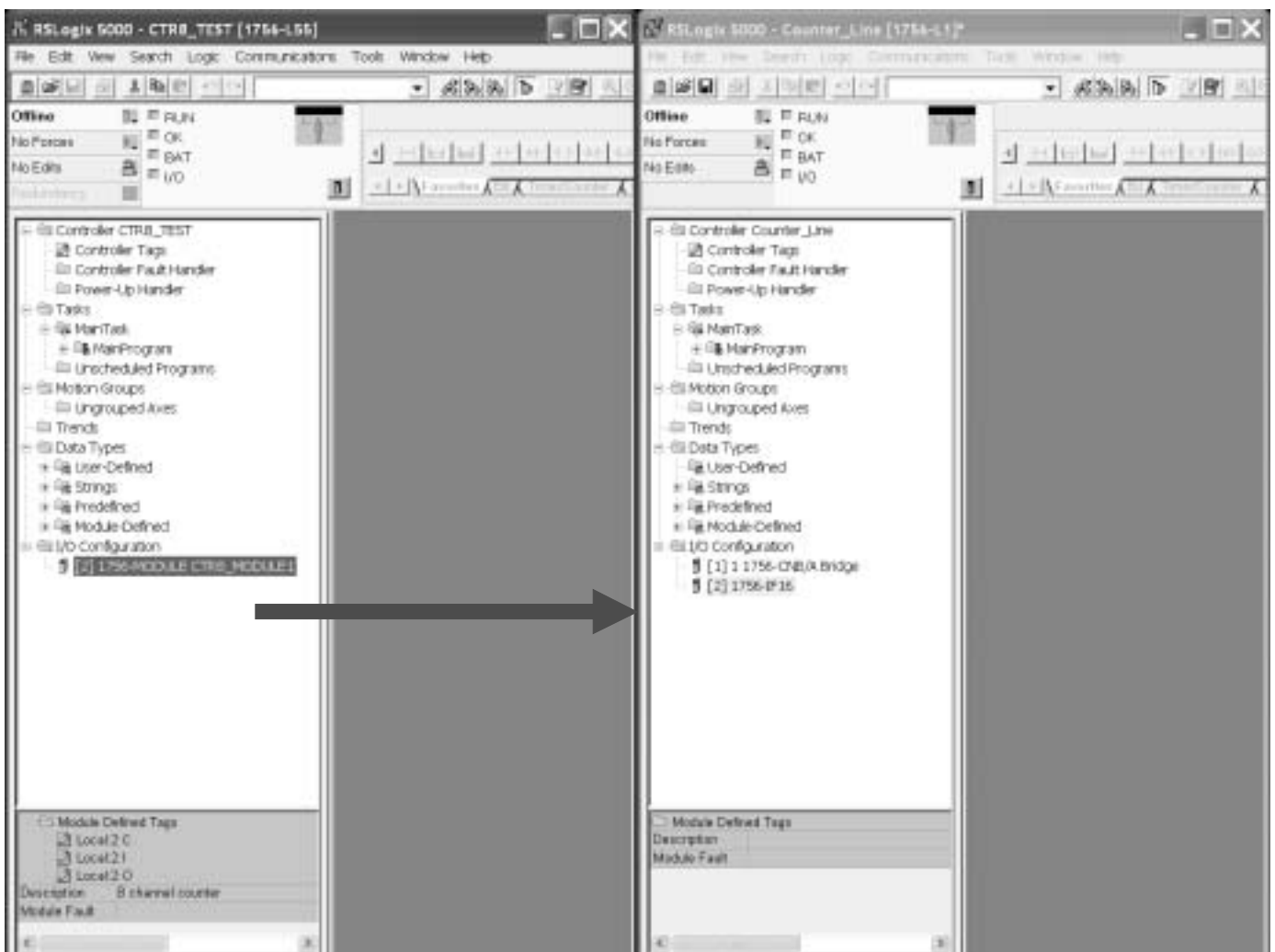

Step 2- Drag and drop the CTR8 user-defined data types from the sample project into your project.

There are three CTR8 user defined data types that need to be moved.

ConfigurationBlock

InputBlock

OutputBlock

1. Click on the data type
2. Drag it into your new project.
3. Continue to drag and drop the data types until all four have been moved.

Note: These can only be moved one at a time.

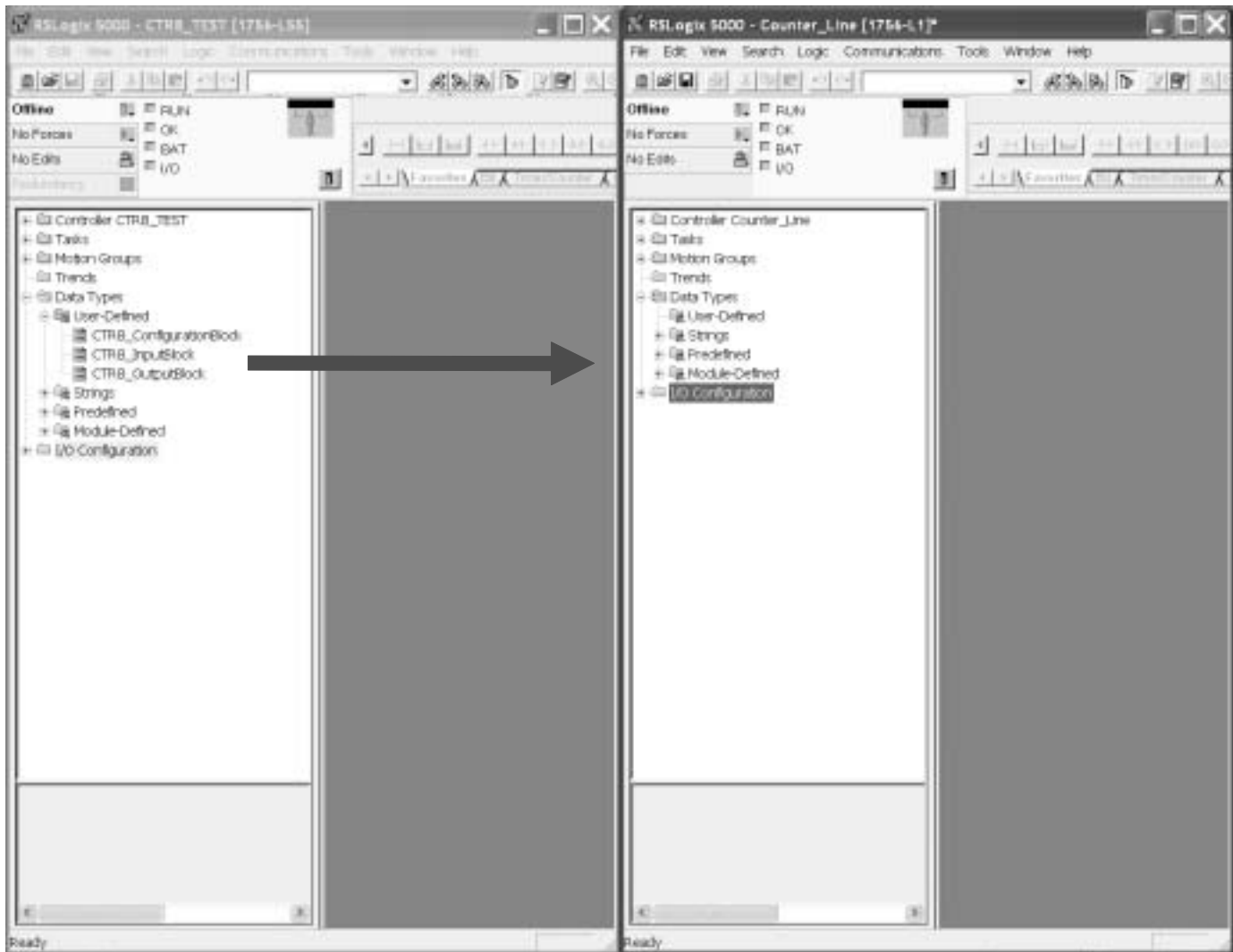

Step 3- Drag and drop the controller configuration tags from the sample project into your project.

1. Right click on the Controller Tags item of the sample project and select edit.
2. Right click on the Controller Tags item of your project and select edit.
3. Scroll down to the Controller tags of the sample project and select all the tags by highlighting them.
4. Drag and drop these tags into your project.

Note: CTR8_Config and CTR8_Input contain the configuration, data and status tags for the CTR8 module. The other tags are used for performing various functions to your module via ladder logic.

Note: Be sure all tags are displayed before moving them. Select Display All from the Edit drop down window.

Note: The “Local:3:I” and “Local:3:C” tags are not copied.

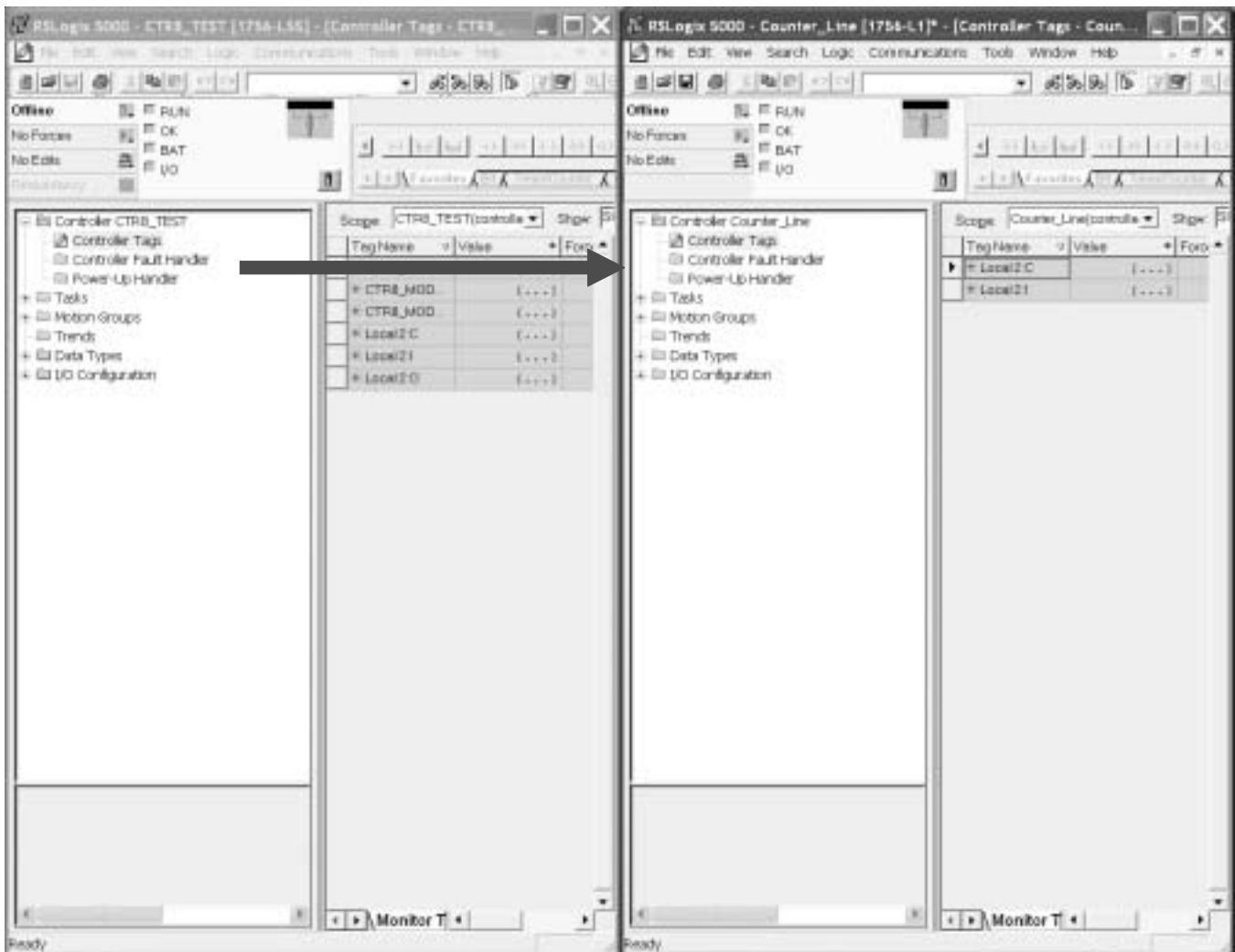

Step 4- Create a new ladder logic routine in your project.

1. In your project, right mouse click on the MainRoutine item and select “New Routine...” CTR8 was entered in the example above.

2. Double click on the MainRoutine item in the sample project and then double click on the added new routine in your project to display their corresponding ladder logic.

3. Left mouse inside the MainProgram ladder logic in the sample project and press ctrl-A to select all the rungs.

4. Drag and drop these rungs over and add them to the new routine’s ladder logic. Note: You will need to delete the one blank “solid bar” rung either at the top or bottom of the routine which was left over from the newly created routine.

5. Now add a JSR ladder instruction in your MainRoutine which calls this routine.

Note: RSLogix 5000 will verify the ladder logic sample. You may receive errors regarding invalid tags. You will need to change the slot addressing in the logic to coordinate with the location of the CTR8.

This completes the installation of module in the system

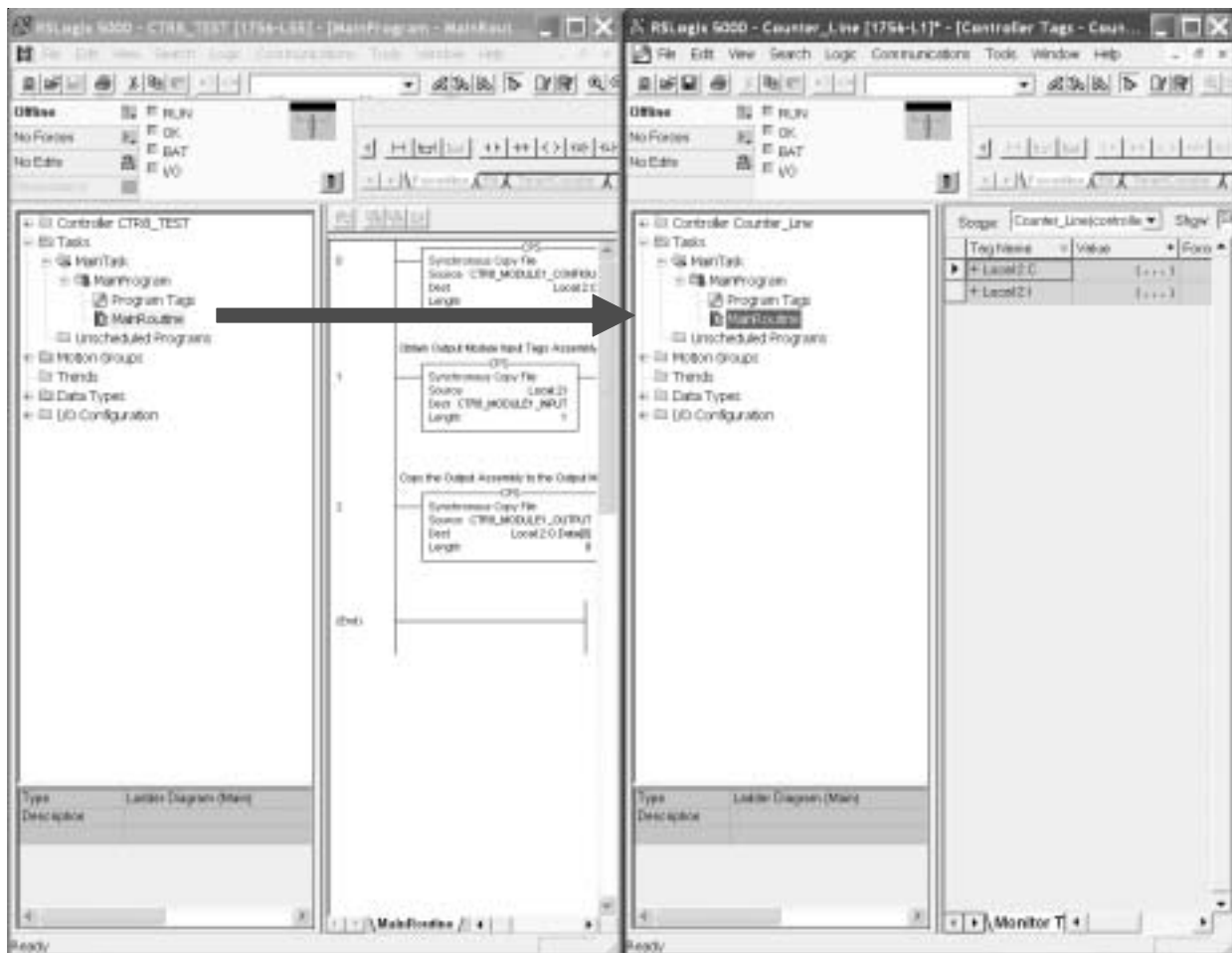

Configuring module attributes: Configuration Tags

The module has settings that are global and channel specific. These are accessed via the controller tags. Specific information regarding these tag settings may be found in Chapter 5.

Channel Specific Tags

These settings control channel specific behavior such as input type, range, filter frequency, units, and alarms. Specific information regarding these tags may be found in Chapter 5.

Tag Name	Value	Force Mask	Style	Type
CTR8_MODULE1_CONFIGURATION	{...}	{...}		CTR8_Configur...
CTR8_MODULE1_CONFIGURATION.CounterLimit	{...}	{...}	Float	REAL[8]
CTR8_MODULE1_CONFIGURATION.Preset	{...}	{...}	Float	REAL[8]
CTR8_MODULE1_CONFIGURATION.RateSamplePeriod	{...}	{...}	Decimal	INT[8]
CTR8_MODULE1_CONFIGURATION.OperationalMode	{...}	{...}	Decimal	SINT[8]
CTR8_MODULE1_CONFIGURATION.StorageMode	{...}	{...}	Decimal	SINT[8]
CTR8_MODULE1_CONFIGURATION.InputRange	{...}	{...}	Decimal	SINT[8]
CTR8_MODULE1_CONFIGURATION.KFactor	{...}	{...}	Float	REAL[8]
CTR8_MODULE1_CONFIGURATION.RFactor	{...}	{...}	Float	REAL[8]
CTR8_MODULE1_CONFIGURATION.MFactor	{...}	{...}	Float	REAL[8]
CTR8_MODULE1_CONFIGURATION.SignalFilter	{...}	{...}	Hex	SINT[8]
CTR8_MODULE1_CONFIGURATION.GateFilter	16#00		Hex	SINT
CTR8_MODULE1_CONFIGURATION.RollOverTo	16#00		Hex	SINT
CTR8_MODULE1_CONFIGURATION.RollUnderTo	16#00		Hex	SINT
CTR8_MODULE1_CONFIGURATION.StopOnZero	16#00		Hex	SINT
CTR8_MODULE1_CONFIGURATION.StopOnLimit	16#00		Hex	SINT

Data Tags

These tags represent the process data values in their final form.

Tag Name	Value	Force Mask	Style	Type
+ CTR8_MODULE1_CONFIGURATION	{...}	{...}		CTR8_Configur...
- CTR8_MODULE1_INPUT	{...}	{...}		CTR8_InputBlock
+ CTR8_MODULE1_INPUT.CommStatus	16#0000_...		Hex	DINT
+ CTR8_MODULE1_INPUT.CountValue	{...}	{...}	Float	REAL[8]
+ CTR8_MODULE1_INPUT.StoredValue	{...}	{...}	Float	REAL[8]
+ CTR8_MODULE1_INPUT.Rate	{...}	{...}	Float	REAL[8]
+ CTR8_MODULE1_INPUT.EnableEcho	16#ff		Hex	SINT
+ CTR8_MODULE1_INPUT.WasReset	16#00		Hex	SINT
+ CTR8_MODULE1_INPUT.WasPreset	16#00		Hex	SINT
+ CTR8_MODULE1_INPUT.NewStoredData	16#00		Hex	SINT
+ CTR8_MODULE1_INPUT.NewRateData	16#ff		Hex	SINT
+ CTR8_MODULE1_INPUT.GateState	16#00		Hex	SINT
+ CTR8_MODULE1_INPUT.CounterInputState	16#ff		Hex	SINT
+ CTR8_MODULE1_INPUT.CountDirection	16#ff		Hex	SINT
+ CTR8_MODULE1_INPUT.CTRLimitFlag	16#00		Hex	SINT
+ CTR8_MODULE1_INPUT.CTRZeroFlag	16#fe		Hex	SINT
+ CTR8_MODULE1_INPUT.CSTTime	{...}	{...}	Decimal	DINT[2]
+ CTR8_MODULE1_OUTPUT	{...}	{...}		CTR8_OutputBl...

Status Tags

These tags report module status such as alarm conditions, faults, and errors.

Tag Name	Value	Force Mask	Style	Type
+ CTR8_MODULE1_CONFIGURATION	{...}	{...}		CTR8_Configur...
+ CTR8_MODULE1_INPUT	{...}	{...}		CTR8_InputBlock
- CTR8_MODULE1_OUTPUT	{...}	{...}		CTR8_OutputBl..
+ CTR8_MODULE1_OUTPUT.Enable	16#00		Hex	SINT
+ CTR8_MODULE1_OUTPUT.ResetCounter	16#00		Hex	SINT
+ CTR8_MODULE1_OUTPUT.LoadPreset	16#00		Hex	SINT
+ CTR8_MODULE1_OUTPUT.ResetFlags	16#00		Hex	SINT
+ CTR8_MODULE1_OUTPUT.CounterInvert	16#ff		Hex	SINT
+ CTR8_MODULE1_OUTPUT.ResetNewRateFlag	16#00		Hex	SINT
+ CTR8_MODULE1_OUTPUT.ResetNewStoredFlag	16#00		Hex	SINT

Configuration, Data, and Status Tags

Read this chapter to:

- send configuration data to the module
- configure global module properties
- configure each input channel
- check each input channel's data
- check module and individual channel status

This chapter outlines the detailed settings for the 1756sc-CTR8. These settings determine the modules input types, filter frequencies, scan rates, and various attributes. Detailed descriptions of these settings are available in the Tag Definition section of this chapter.

Note: The following format is used to describe tags

Tag Name	Range	Data Type
-----------------	--------------	------------------

Send Configuration Data to the Module

After changing the configuration tags in this chapter you must then send them to the module. To do this you may perform any of these operations:

1. Inhibit then un-inhibit the module via the module properties dialog, Connection Tab
2. Reset the module via the modules properties dialog. Module Info tab.
3. Reset the module via ladder logic. See the “DoReset” rung in the sample ladder project.
4. Perform a “Set Attribute All” or Module Reconfigure message instruction via ladder logic. Refer to your sample program for information about the “DoSetAttrAll” command.

Note: If an invalid configuration is sent to the module a connection error will occur. See chapter 7 for a list of error codes.

Configuration Tags

The following Global Module Settings and Channel Specific Settings sections allow custom configuration of the module. These tags can be found within the CTR8_config controller tags.

Channel Specific Settings

[x] designates the channel number

(C) designates the value may be changed during module operation

CountLimit[x] 0 - 16777215 FLOAT (C)

Designates the channel rollover value. The maximum value is 1677215 when scaling is off. When scaling is applied the maximum value is $1677215/K * M$.

Preset[x] 0 - 16777215 FLOAT (C)

Designates the channel preset value. Module begins counting at this value. **IMPORTANT:** This value cannot be greater than the rollover value. The maximum value is 1677215 when scaling is off. When scaling is applied the maximum value is $1677215/K * M$.

RateSamplePeriod[x] 0-2000 INT

When using period/rate mode, set this value as a multiple of 10ms between 0 and 2000. This becomes the integration time over which rate data is averaged.

OperationalMode[x] 0,1 INT

Designates channel operational mode.

0 = unidirectional counter mode (Up)

1 = bidirectional counter mode (Up / Down)

2 = encoder X1 mode

3 = encoder X4 mode

Note: Channels must be configured in pairs. (0,1) (2,3) (3,4) (4,5) (5,6) (6,7)

Input configurations determine how the 8 inputs cause the counter to increment or decrement. The four available configurations are:

- Uni-Directional (up)
- Bi-Directional (up and down using two channels)
- X1 Quadrature Encoder
- X4 Quadrature Encoder

Uni-Directional

With this configuration, the input increments in an upward direction. All 8 channels may be configured in the unidirectional mode. Every clock pulse will increment the counter on the rising edge. Note: The direction of the counter may be inverted by setting the Count Direction bit described in the Configuration chapter.

Bi-Directional

The bidirectional counter requires 2 input channels. In this mode one channel is used as the counter input and the 2nd channel is used to determine the count direction. The counter will increment when the Direction Channel value is 0, and will decrement when the Counter Direction Channel value is 1.

X1 Quadrature Encoder

The quadrature mode requires 2 input channels. When a quadrature encoder is attached to an input channel pair, A and B, the count direction is determined by the phase angle between inputs A and B. If A leads B, the counter increments. If B leads A, the counter decrements. (The counter changes value *only* on one edge of input 1.) The counter increments once per quadrature cycle.

Note: The Quadrature mode provides additional Anti-Jitter circuitry. This distinguishes between a valid quadrature sequence and an invalid sequence due to electrical noise or jitter. Jitter can occur if a quadrature encoder stops rotating right at an input sensor trip point. This can cause additional unwanted clock pulses. Quadrature mode can detect invalid transitions and filter these out.

X4 Quadrature Encoder

Like the X1 quadrature encoder, the count direction is determined by the phase angle between inputs A and B. If A leads B, the counter increments. If B leads A, the counter decrements. However, the counter changes value on the rising and falling edges of inputs A and B. The counter increments four times per quadrature cycle.

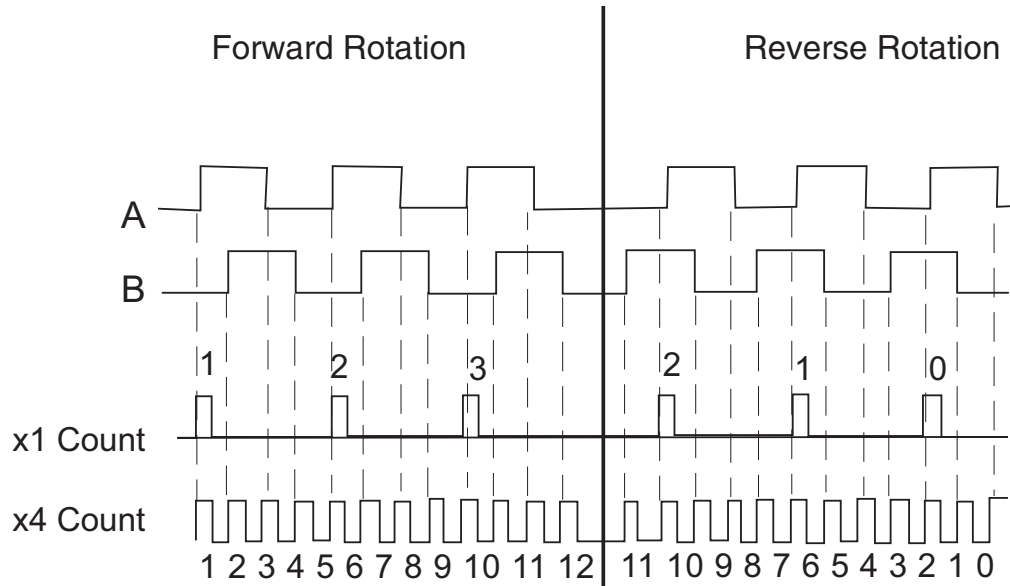
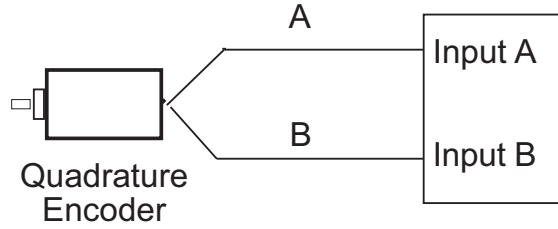

StorageMode[x] 0-4 INT (C)

This mode determines how the gate behavior effects counter behavior.

- 0 = no store mode
- 1 = store and continue mode
- 2 = store, wait, and resume mode
- 3 = store and reset, wait, and start mode
- 4 = store and reset, and start mode

The behaviors are characterized as follow:

StorageMode = 0 - No gate activity stored

StorageMode = 1 - Read, Store count, and continue counting.

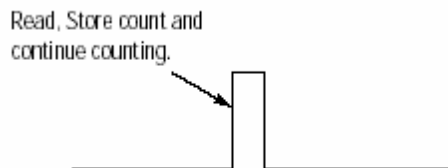

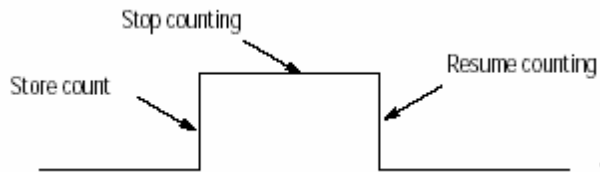
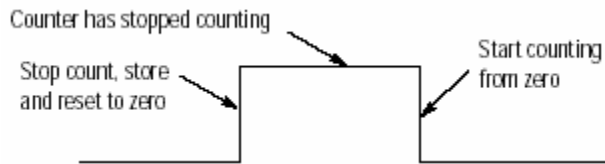
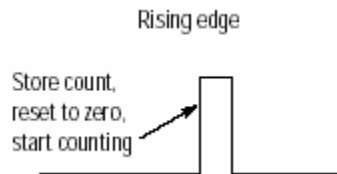
StorageMode = 2 - Store/Wait/Resume**StorageMode = 3 - Store-Reset/Wait/Start****StorageMode = 4 - Store-Reset/Start****InputRange[x] 0,1 INT**

This setting determines the threshold where the counter will begin to trigger. Select the range that is best suited to your sensor's range.

- 0= AC 50mVpp threshold
- 1= AC 200mVpp threshold
- 2= 5V
- 3= 12V/24V

KFactor[x] 0 - 1x10³² FLOAT (C)

The K scale factor is used for counter scaling. This allows users to scale the counter output into more useful units, like gallons per minute. When a non-zero Scale Factor value is set the scale calculation is always performed. A value of zero must be written to the Scale Factor to disable this feature. This counter value is divided by the K factor. K factors are positive numbers.

RFactor[x] 0 - 1x10³² FLOAT (C)

In Program Mode the data value in this register is used for scaling. The M scale factor is used for meter calibration. When a non-zero Scale Factor value is set the scale calculation is always performed. A value of zero must be written to the Scale Factor to disable this feature.

The M factor value expressed as a floating point number. This value is multiplied by the counter actual count value, and gives the M factor a range of +/- TBD (Prior counter modules we produced have been +/- 3.2765). Most M factors will be within +/- 5% of 1.0000.

MFactor[x] **0 - 1x10³²** **FLOAT** **(C)**

The R scale factor can be used for scaling of the output frequency. The output frequency is divided by the R scale value. The frequency value is divided by the R factor. R factors must be positive numbers. A negative value will cause a configuration error.

SignalFilter[x] **0-3** **INT**

Designates whether channel 0 uses the analog filter

0 = do not use analog or digital filter

1 = use digital filter (25kHz)

2 = use both digital (25kHz) and analog (12kHz) filters

3 = use digital (25kHz), analog (12kHz), and debounce filter (30Hz)

NOTE: The digital and analog filters are separate entities which are combined into the same tag on this module. The debounce filter debounces the input for 35 to 40msec after the input transitions.

GateFilter[x] **0,1** **INT**

0 = No filter

1 = Debounce filter.

The debounce filter debounces the input for 35 to 40msec after the input transitions.

RollOverTo[x] **0,1** **BOOL** **(C)**

Designates which value channel 0 will roll-over to:

0 = zero

1 = preset

RollUnderTo[x] **0,1** **BOOL** **(C)**

Designates which value channel 0 will roll-under to:

0 = normal (max value)

1 = preset

Stoponzero[x] **0,1** **BOOL** **(C)**

Designates what channel 0 will do when it counts down to 0.

0 = roll-under

1 = stop at zero

Stoponlimit[x] **0,1** **BOOL** **(C)**

Designates what channel 0 will do when it counts up to the count_limit.

0 = rollover

1 = stop at the limit

Output Tags

Disable[x]	0,1	BOOL
Enable the counter for channel [x]. 0=enable 1=disable		
ResetCounter[x]	0,1	BOOL
Resets counter 0 and begins counting. 0 = do not reset 1 = reset		
LoadPreset[x]	0,1	BOOL
Loads preset count value into counter [x] and begins counting. 0 = no action 1 = load preset		
ResetFlags[x]	0,1	BOOL
Reset all flags. 0=not Reset 1=Reset		
CounterInvert[x]	0,1	BOOL
Invert current direction of counter. 0=Standard 1=Inverted		
ResetNewStoredFlag[x]	0,1	BOOL
Reset new stored data flag. 0=not Reset 1=Reset		
ResetNewRateFlag[x]	0,1	BOOL
Reset rate data flag. 0=not Reset 1=Reset		

Input Tags

The following data tags are preceded by the tag name CTR8_Input.ChannelData[x] where x is the channel number 0-7.

CommStatus	0,65535	DINT
Displays module connection status. 0 = module is connected 65535 = module is not connected		
Count[x]	0-16777215	FLOAT
Displays the channel count value.		

StoredValue[x]	0-16777215	FLOAT
Displays the value of the stored stored counts register. The maximum value is 1677215 when scaling is off. When scaling is applied the maximum value is 1677215/K*M.		
Rate[x]	0-65,000	REAL
Current rate value.		
EnableEcho[x]	0,1	BOOL
Software enable for the channel. This is an echo of the output tag. 0=Enable 1=Disable		
WasReset[x]	0,1	BOOL
Displays whether the channel counter was reset. 0 = Counter was not reset 1 = Counter was reset		
WasPreset[x]	0,1	BOOL
Displays whether the preset value for the channel counter was loaded. 0 = Preset value was not loaded 1 = Preset value was loaded		
NewStoredData	0,1	BOOL
0 = Data not stored 1 = Data Stored		
NewRateData	0,1	BOOL
0 = Data is Old 1 = Data is New		
GateState[x]	0,1	BOOL
Displays the channel Z state. 0 = Gate is Not Active 1 = Gate is Active		
CounterInputState[x]	0,1	BOOL
This echos the state of the input. Note that this is also impacted by the gate and/or enable line.		
CountDirection[x]	0,1	BOOL
0 = Counting up 1 = Counting down		
CTRLimit[x]	0,1	BOOL
This flag is latched when counts are equal to the user defined limit. 0 = Not set 1 = Set		
CTRZero[x]	0,1	BOOL
0 = Not set 1 = Set		

CST

Coordinated System Time. This is the time that the processor reads data from the FPGA. It is not the actual time that the count occurred. There will only be one CST tag for the entire module.

DINT

Programming Examples

Earlier chapters explained how the tag configuration defines the way the module operates. This chapter shows some basic programming which controls the operation of the module. It also provides you with segments of ladder logic specific to unique situations that might apply to your programming requirements.

Initial Programming

Figure 6.1 illustrates some basic ladder logic commands which will allow you to:

- program the initial configuration into the module
- copy data to user defined tags
- reset the module
- make on-the-fly configuration changes
- unlatch alarms

Additional ladder logic and configuration samples may also be found on our web site: **www.spectrumcontrols.com**.

Figure 5.1 Sample Ladder Logic

Rung 0 - This rung copies the configuration data (CTR8_Config) into the module's configuration image memory. This rung is required.

Rung 1 - This rung copies the input data received from the module's input memory into the CTR8_Input tag for monitoring and ladder usage. This rung is required.

Rung 2 - This is an optional example rung indicating how to reset the module via ladder logic.

Rung 3 - This is an optional example rung indicating how to send on-the-fly configuration data to the module. This is useful if you would like to change channel alarm or scaling tags without causing interruption in channel updates. Changing other tags will cause a 2.5 second delay in channel updates but the connection will not be interrupted.



You may use either the SetAttributeAll to accomplish this.

Set Attribute All message:

The screenshot shows a dialog box titled "Message Configuration - MsgSetAttributeAll". It has three tabs: "Configuration", "Communication", and "Tag". The "Configuration" tab is active. The dialog contains the following fields and controls:

- Message Type:** A dropdown menu set to "CIP Generic".
- Service Type:** A dropdown menu set to "Custom".
- Source Element:** A dropdown menu set to "IF8U_Config".
- Source Length:** A numeric input field set to "396" with "(Bytes)" next to it.
- Service Code:** A numeric input field set to "4c" with "(Hex)" next to it.
- Class:** A numeric input field set to "4" with "(Hex)" next to it.
- Destination:** A dropdown menu.
- Instance:** A numeric input field set to "225".
- Attribute:** A numeric input field set to "0" with "(Hex)" next to it.
- New Tag...:** A button located below the Destination dropdown.
- Enable:** A radio button.
- Enable Waiting:** A radio button.
- Start:** A radio button.
- Done:** A radio button.
- Done Length:** A numeric input field set to "0".
- Error Code:** A radio button.
- Extended Error Code:** A radio button.
- Timed Out:** A checkbox.
- Error Path:** A text input field.
- Error Text:** A text input field.
- Buttons:** "OK", "Cancel", "Apply", and "Help" buttons at the bottom right.

Using the gate storage mode

The gate storage mode allows you to configure the external gate to react in several ways. The StorageMode[x] tag has 5 valid configurations:

StorageMode[x]

This mode determines how the gate behavior effects counter behavior.

0 = no store mode

1 = store and continue mode

2 = store, wait, and resume mode

3 = store and reset, wait, and start mode

4 = store and reset, and start mode

StorageMode = 1 - Read, Store count, and continue counting

This mode could be used in a cutting operation to determine the length of the cut material. When the gate is triggered the current count value is stored and the counter continues to count. The length of the material would then be determined by subtracting the correct count value from the stored value.

The gate behavior

Read, Store count and
continue counting.

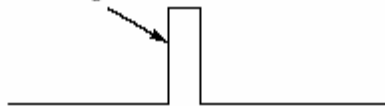

StorageMode = 2 - Store/Wait/Resume

This mode may be used in a situation where accumulated count is important but the process may stop. For instance, if you are running a filling line and want to know the daily production a flowmeter will measure the total quantity even through start/stop cycles.

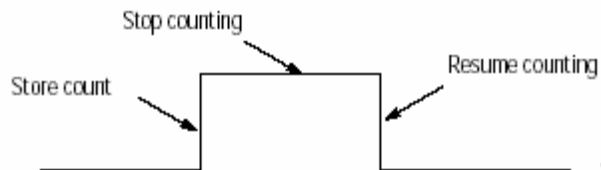

StorageMode = 3 - Store-Reset/Wait/Start

This mode could be used in a bottle filling line when you want to control the precise amount being dispensed. The fill occurs, the enable is triggered and the bottle moves. The next bottle comes into place and the fill starts at zero.

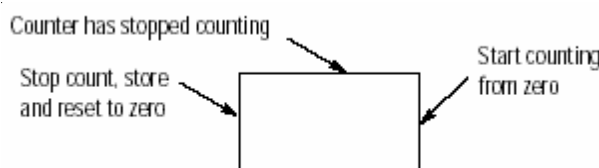

StorageMode = 4 - Store-Reset/Start

This mode could be used for a meter proving line when there are two trigger points, a start and a stop. A pulse trigger caused by a ball crossing a proximity switch zeros the counter and starts the accumulation. When the ball reaches the end of the run another pulse occurs stopping and storing the accumulated value.

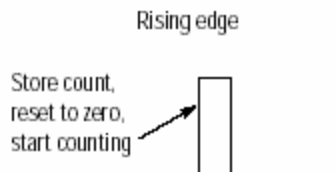

Installation Recommendations

High Impedance Inputs

If the input device is an open collector type it may be necessary to use a pull up or pull down resistor in order to achieve the proper threshold crossover point. We recommend stating is a 1kohm resistor and typing it between the input path and ground to pull down or the input path an a +12/24V source for pull up.

Filter Frequency Settings

Use of digital filters will insure best possible performance. Recommendations are as follows:

Maximum Signal Input	Filter
65kHz	No Filtering
25kHz	25kHz Digital Filter
12kHz	25kHz and 12kHz Filters

Debounce Filter

The debounce filter is best used when the gate input is connected to low frequency input devices such as relays or proximity switches. These devices do not typically have any on-board debounce circuitry.

Meter Proving

The 1756sc-CTR8 module provides a feature that allows the user to perform meter proving functions. A typical meter proving application would include two detector sensors that are located a fixed distance from each other within a section of pipe used specifically for meter proving. The operation does not disrupt the in situ flowmeter's operation.

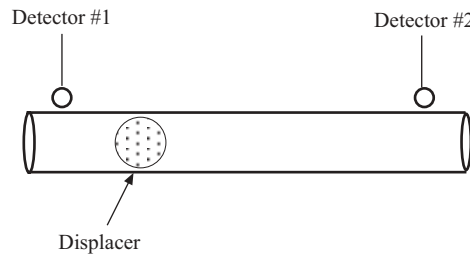

Utilizing the external gate enable to start and stop count functions enables the user to count pulses as fast as 65kHz to an accuracy of 1 count.

Here is an example wave form representing the start and stop transitions on the external gate enable, and the associated pulses that the module would accumulate: [Storage mode 3, store, reset, wait, start]

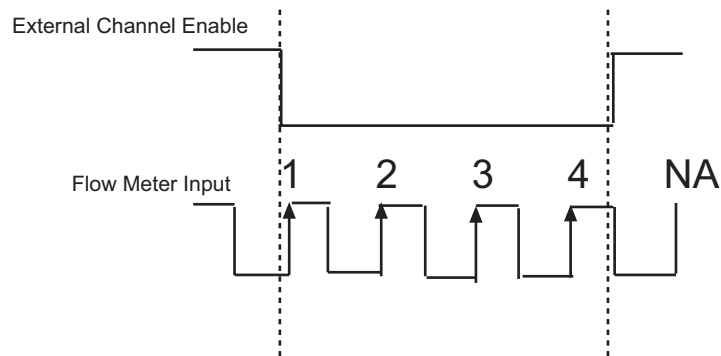

Given the above wave form, the module will begin counting the first positive going input pulse after the external enable input goes low. The module will accumulate 4 counts in the channel count register and stop when the external enable input goes high.

Troubleshooting

Using Module Indicators to Troubleshoot

The count module has indicators which provide indication of module status. ControlLogix modules use the following:

LED	This display:	Means	Take this action:
OK	Steady Green Light	The inputs are being multicast	None
OK	Flashing Green Light	The module has passed internal diagnostics but is not currently performing connected communication	None
OK	Flashing Red Light	Previously established communication has timed out and chassis communications	Check controller
OK	Steady Red Light	It is likely the module should be replaced	See below

Under fault conditions the CTR8 will communicate a particular error via a LED blink code. A description of the fault conditions and LED blink codes is listed below...

OK LED	SYS LED	Fault Status
RED	1 Blink	EEPROM seed completed.
RED	2 Blinks	EEPROM seed failed.
RED	3 Blinks	EEPROM CRC failed.
RED	4 Blinks	Invalid serial number.
RED	5 Blinks	Boot code CRC failed.
RED	6 Blinks	App CRC failed.
RED	7 Blinks	FPGA configuration fail.
RED	8 Blinks	FPGA scan fail.
RED	9 Blinks	Not Applicable
RED	10 Blinks	XA Watchdog timeout.

In most instances you may try resetting the module to clear the fault. If you are not successful, contact technical support as the module may require repair.

Note: In RSLogix5000 the Fault Status can be seen in the “Module Info” tab of the module’s properties dialog.

The following LED display is used with ControlLogix analog input modules:



Using RSLogix 5000 to Troubleshoot Your Module

In addition to the LED display on the module, RSLogix 5000 will alert you to fault conditions. You will be alerted in one of three ways:

- Warning signal on the main screen next to the module-This occurs when the connection to the module is broken
- Fault message in a screen's status line · Notification in the Tag Editor - General module faults are also reported in the Tag Editor. Diagnostic faults are only reported in the Tag Editor
- Status on the Module Info Page

The screens below display fault notification in RSLogix 5000.

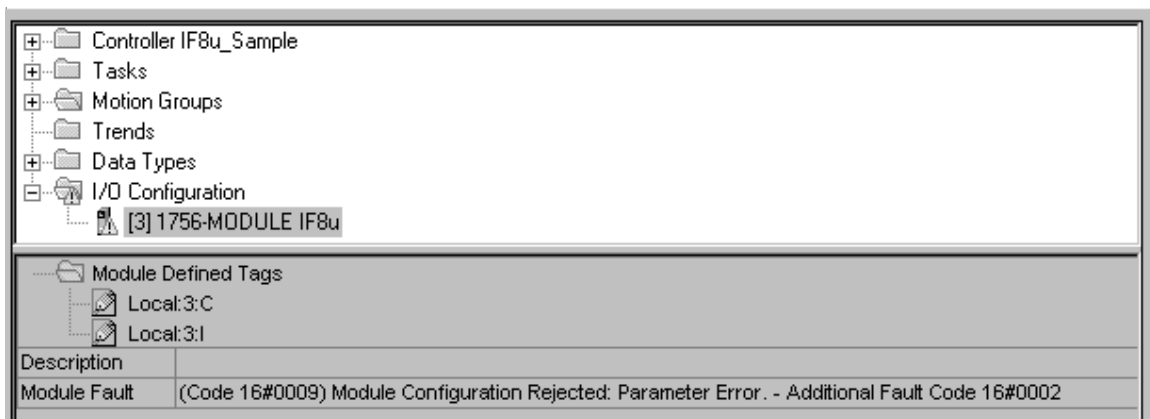

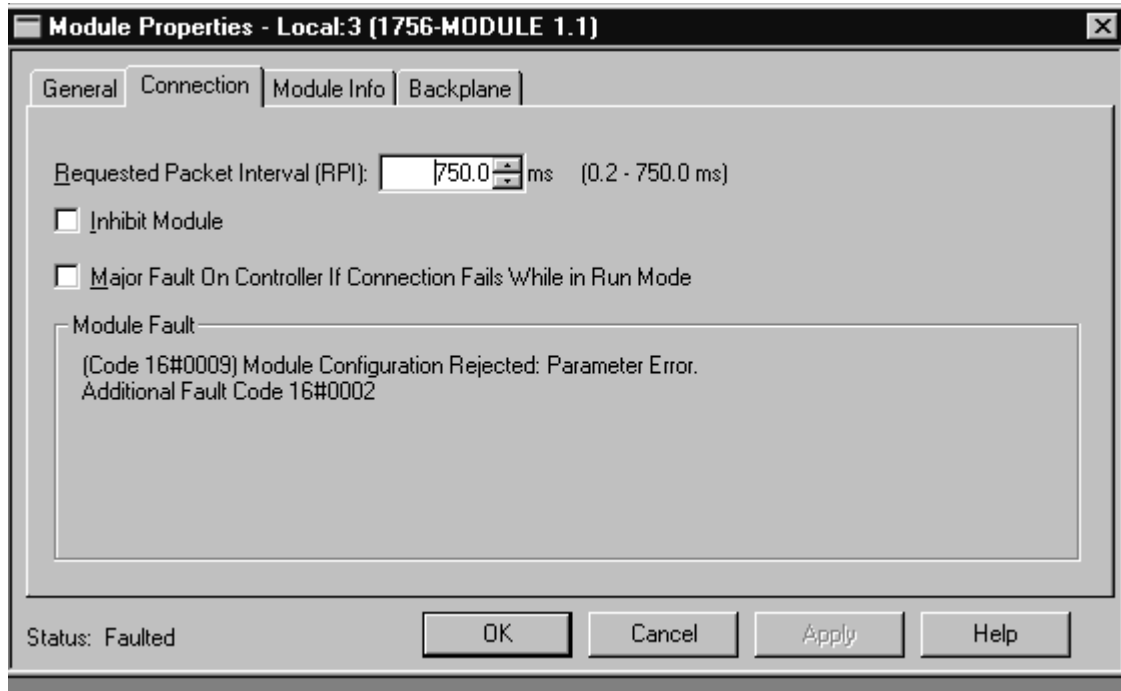

Fault information on the properties screen.

Determining Fault Type

When you are monitoring a module's properties dialog in RSLogix 5000 and receive a fault message, the module fault area lists the type of fault.

Module Configuration Errors

The "Additional Fault Code" value details the configuration error if the "(16#0009) module configuration rejected: Parameter Error" was received.

Global Errors

16#0F04 - .ConfigurationRevError

If the .ConfigurationRevNumber tag is 1 and a second owner attempts to connect with a different configuration, this error will occur. You must adjust the second owners configuration to match the first.

16#0F05 - .ConfiguratinRevNumber Error

An invalid value has been entered into this tag.

Channel Specific Errors

Note: n = channel number (0-7)

- 0x010(n) Preset is defined larger than rollover limit for channel (n).
- 0x0200 Input Range mismatch for channel pair 0 and 1.
- 0x0202 Input Range mismatch for channel pair 2 and 3.
- 0x0204 Input Range mismatch for channel pair 4 and 5.
- 0x0206 Input Range mismatch for channel pair 5 and 7.
- 0x030(n) Invalid operational mode for channel (n).
- 0x040(n) Invalid storage mode for channel (n).
- 0x050(n) Invalid input range for channel (n).
- 0x060(n) Invalid signal filter for channel (n).
- 0x070(n) RateSamplePeriod out of range for channel (n).
- 0x0800 Operational mode mismatch for channel pair 0 and 1.
- 0x0802 Operational mode mismatch for channel pair 2 and 3.
- 0x0804 Operational mode mismatch for channel pair 4 and 5.
- 0x0806 Operational mode mismatch for channel pair 6 and 7.
- 0x090(n) Preset too high for channel (n).
- 0x0A0(n) Count limit too high for channel (n).
- 0x0B0(n) RateSamplePeriod not divisible by 10 for channel (n).

Note: If there are multiple errors in the configuration tags only one will be displayed at a time. Once the displayed error has been corrected, the additional errors will be displayed upon reconnection to the module. Each error must be resolved before a running connection will be allowed.

Maintaining Your Module And Ensuring Safety

Read this chapter to familiarize yourself with:

- preventive maintenance
- safety considerations

The National Fire Protection Association (NFPA) recommends maintenance procedures for electrical equipment. Refer to article 70B of the NFPA for general safety-related work practices.

Preventive Maintenance

The printed circuit boards of your module must be protected from dirt, oil, moisture, and other airborne contaminants. To protect these boards, install the ControlLogix system in an enclosure suitable for its operating environment. Keep the interior of the enclosure clean, and whenever possible, keep the enclosure door closed.

Also, regularly inspect the terminal connections for tightness. Loose connections may cause a malfunctioning of the SLC system or damage to the components.



WARNING

POSSIBLE LOOSE CONNECTIONS

Before inspecting connections, always ensure that incoming power is OFF.

Failure to observe this precaution can cause personal injury and equipment damage.

Safety Considerations

Safety is always the most important consideration. Actively think about the safety of yourself and others, as well as the condition of your equipment. The following are some things to consider:

Indicator Lights – When the module status LED on your module is illuminated, your module is receiving power.

Activating Devices When Troubleshooting – Never reach into a machine to activate a device; the machine may move unexpectedly. Use a wooden stick.

Standing Clear Of Machinery – When troubleshooting a problem with any ControlLogix system, have all personnel remain clear of machinery. The problem may be intermittent, and the machine may move unexpectedly. Have someone ready to operate an emergency stop switch.



CAUTION

POSSIBLE EQUIPMENT OPERATION

Never reach into a machine to actuate a switch. Also, remove all electrical power at the main power disconnect switches before checking electrical connections or inputs/outputs causing machine motion.

Failure to observe these precautions can cause personal injury or equipment damage.

Safety Circuits – Circuits installed on machinery for safety reasons (like over-travel limit switches, stop push-buttons, and interlocks) should always be hard-wired to the master control relay. These circuits should also be wired in series so that when any one circuit opens, the master control relay is de-energized, thereby removing power. Never modify these circuits to defeat their function. Serious injury or equipment damage may result.



WARNING

EXPLOSION HAZARD

SUBSTITUTION OF COMPONENTS MAY IMPAIR SUITABILITY FOR CLASS I DIVISION 2.



WARNING

EXPLOSION HAZARD

DO NOT DISCONNECT EQUIPMENT UNLESS POWER HAS BEEN SWITCHED OFF OR THE AREA IS KNOWN TO BE NON-HAZARDOUS

NOTE: THIS EQUIPMENT IS SUITABLE FOR USE IN CLASS I, DIVISION 2, GROUPS A, B, C, AND D OR NON-HAZARDOUS LOCATIONS ONLY.

WARNING**EXPLOSION HAZARD**

WHEN IN HAZARDOUS LOCATIONS, TURN OFF
POWER BEFORE REPLACING OR WIRING MODULES.

WARNING

THIS DEVICE IS INTENDED TO ONLY BE USED WITH
THE ALLEN-BRADLEY CONTROLLOGIX 1756 I/O
SYSTEM.

Module Specifications

This appendix lists the specifications for the 1756sc-CTR8 Counter Module.

Electrical Specifications

Backplane Current Consumption	230 mA at 5 VDC 75 mA at 24 VDC
Backplane Power Consumption	3.00W maximum (0.6W @ 5 VDC, 2.4W @ 24 VDC)
Maximum Power Dissipation	4.8W (All inputs at maximum voltage)
Number of Channels	8 unidirectional / 4 bi-directional and quadrature
Number of Gates	8 gate inputs
I/O Chassis Location	Any I/O module slot
Conversion Method	FPGA
Input Filtering	Three user selectable filters (12kHz, 25kHz, debounce)
Calibration	Module does not require calibration
Input Overvoltage Protection	+50VDC cont. 50VACrms
Input Overcurrent Protection	< 4ma @ 50VDC
Isolation	2550 VDC continuous between inputs and chassis ground and between inputs and backplane.
Physical Specifications	
LED Indicators	1 red/green status indicators, 1 red system status
Recommended Cable:	Shielded twisted pair extension wire Belden 8761 or equivalent shielded Belden #9501
Maximum Wire Size	One 16AWG wire or two 22AWG wires per terminal

Environmental Specifications

Operating Temperature	0°C to 60°C (32°F to 140°F)
Storage Temperature	-40°C to 85°C (-40°F to 185°F)
Relative Humidity	5% to 95% (without condensation)
Certification	CE, UL & CUL approved
Hazardous Environment Classification	Class 1 Division 2 Hazardous Environment Groups A, B, C, D
UL 508	
73/23/EEC Low Voltage Directive	
89/336/EEC Electromagnetic Compatibility	
CSA (Class 1, Div 2, Group A,B,C,D)	
CE compliance to EN 61010-1 and EN 61131-2, EN61000-6-2:2001, EN61000-6-4:2001	
EN61010-1:2001, EN61131-2:1994 + A11:1996 + A12:2000	
FM (Class 1, Div 2, Group A,B,C,D)	

Input Specifications

Voltage Range	AC 50mVpp	AC 200mVpp	5VDC	12/24VDC
VIL	-50mV	-200mV	1V	6
VIH	+50mV	+200mV	3.5V	10.5
Vmax CE	+50VACrms	+50VACrms	+50VDC	+50VDC

Current Range 4ma Max @ 50VDC

Input impedance

Resistance Voltage dependent >1Mohm at 5V, 24k typ at 24V.

Capacitance 600pF typical

Counter Speed 0 to 65kHz

Input Frequency 0 to 65kHz

Counter Gate Input

VIL 1.0V min

VIH 3.5V max

Vmax 30V

Min/Max Duty Cycle

Input Range	Max Frequency	Min Duty Cycle	Max Duty Cycle	Min Pulse Width
AC (50mV)	65kHz	NA	NA	NA
AC (200mV)	65kHz	NA	NA	NA
5VDC	65kHz	30	60	4.6usec
12VDC	65kHz	35	70	5.4usec
24VDC	65kHz	25	55	3.8usec

Channel Update Time

With scaling 13ms for all 8 channels.

Accuracy

Frequency Mode	1HzAccuracy max	65kHzAccuracy typ	max
Instant*	+/-0.00Hz	+/-354Hz	+/-354Hz
Average	+/-0.5Hz	+/-1Hz	+/-2Hz

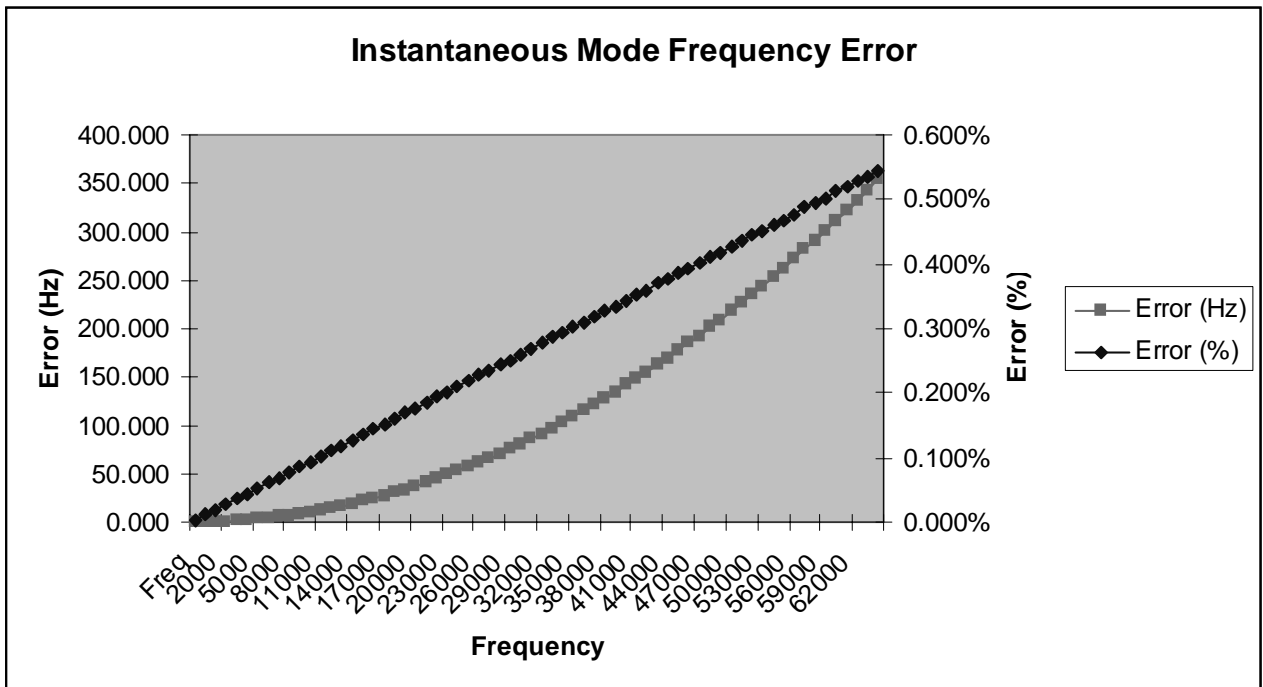
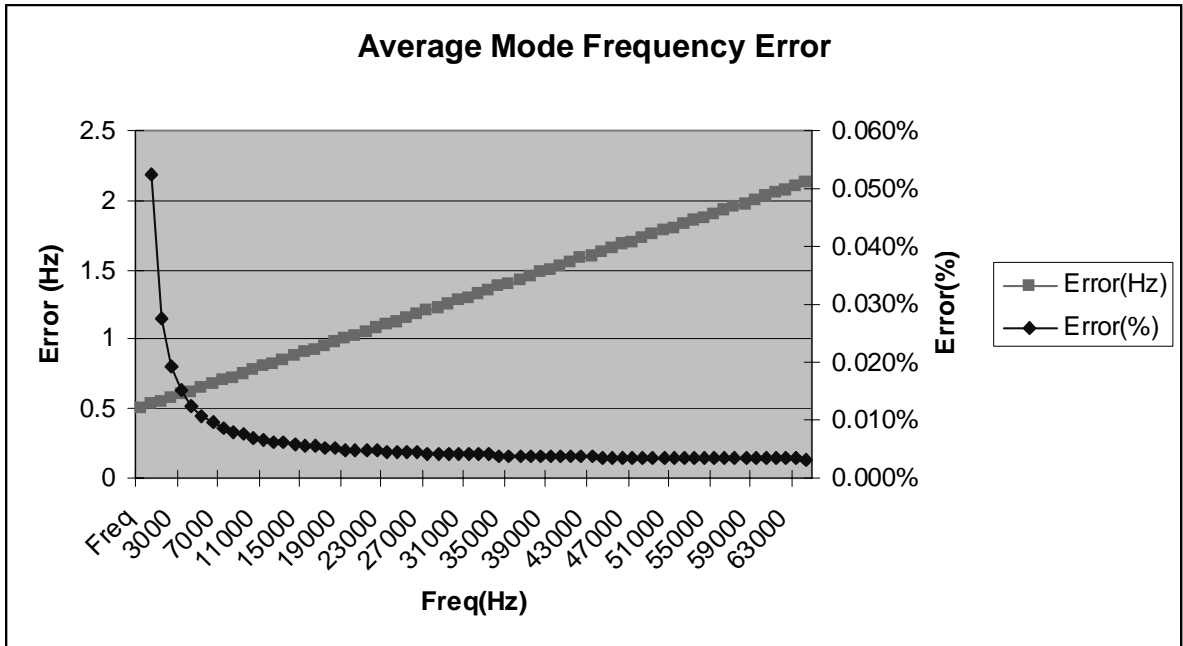

Programming Your Module

This chapter explains how program your module in the ControlLogix system. It also describes how to the module's input configuration are incorporated into your ladder logic program. Topics discussed include:

- importing the module's configuration profile
- reviewing accessing and altering configuration options.
- configuring the modules input type and filter settings
- configuring alarms and limits

Module Installation

Incorporating your module into the system is similar to adding any type of I/O module. You will use your RSLogix 5000 programming software. The module is not currently in the pick list of this software so you will use the Generic 1756 Module option as your starting point. This feature allows you to inport the configuration database into your project and use ladder logic to set the attributes of each tag. These settings control features such as the modules input type, channel input range, data format, filter frequency, etc.

You will need to download the sample project from our website and then import this into your program. Then you may access the controller tags to configure the module. Ladder logic samples are also provided with this sample project.

Adding Your Module to a Project

The module has a unique set of tag definitions which are used to configure specific features. Chapter 5, *Channel Configuration, Data, and Status*, gives you detailed information about the data content of the configuration. These values are set using your programming software and ladder logic. Before you can use these feature you must first include the module into the project.

1. Open your project and go to the “Add I/O module” menu under controller configuration.

2. You will now see the list of all I/O modules. Select the “Generic 1756 I/O” option.

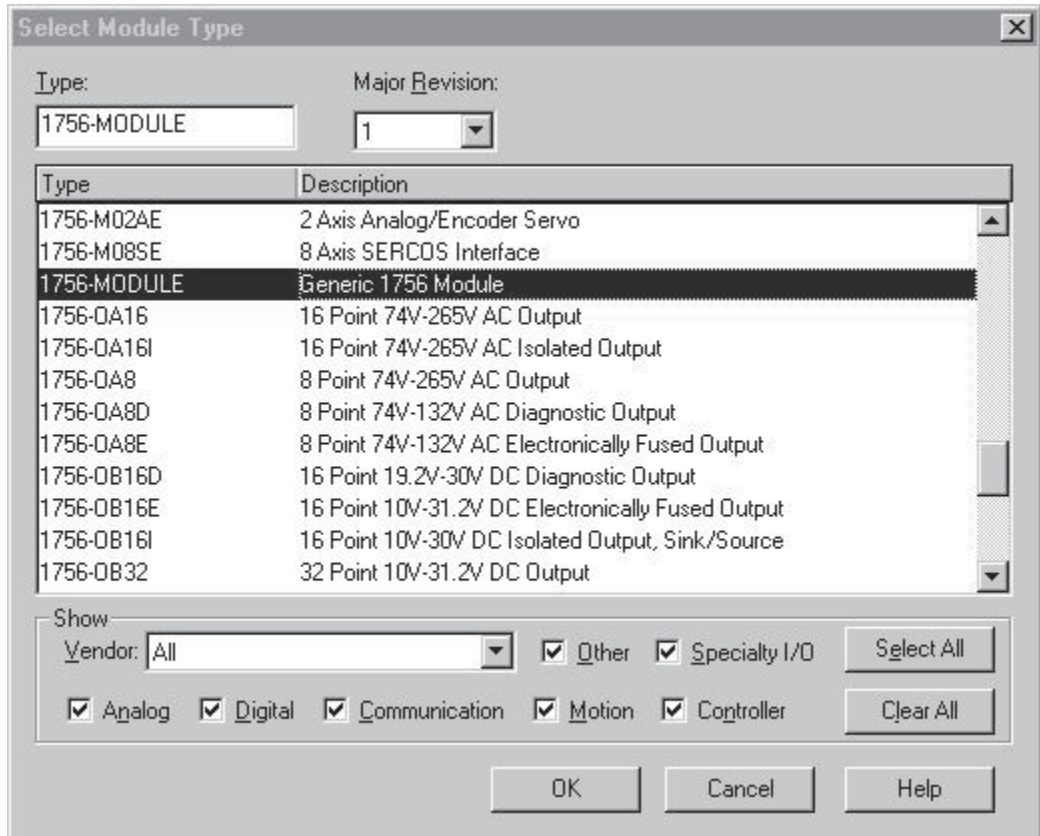

3. After clicking “OK” you are presented with the following dialog for setting up the general information about the module. Use the same values specified here:

Owner Controller Connection (Controller provides configuration)

Module Properties - Local:1 (1756-MODULE 1.1)

Type: 1756-MODULE Generic 1756 Module
 Parent: Local

Name: IF8U
 Description:
 Comm Format: Input Data - DINT
 Slot: 1

Connection Parameters

	Assembly Instance:	Size:	
Input:	225	23	(32-bit)
Output:	227		
Configuration:	225	396	(8-bit)
Status Input:			
Status Output:			

Buttons: Cancel, < Back, Next >, Finish >>, Help

Listen-only controller connection. (Controller does not provide configuration but monitors input data only. Another owner controller must exist.)

Module Properties - Local:2 (1756-MODULE 1.1)

General | Connection | Module Info | Backplane

Type: 1756-MODULE Generic 1756 Module
 Parent: Local

Name: IF8U
 Description:
 Comm Format: Input Data - DINT
 Slot: 2

Connection Parameters

	Assembly Instance:	Size:	
Input:	226	23	(32-bit)
Output:	229		
Configuration:	228	1	(8-bit)
Status Input:			
Status Output:			

Status: Offline

Buttons: OK, Cancel, Apply, Help

4. Specify an RPI interval between 10.0 and 750.0 ms:

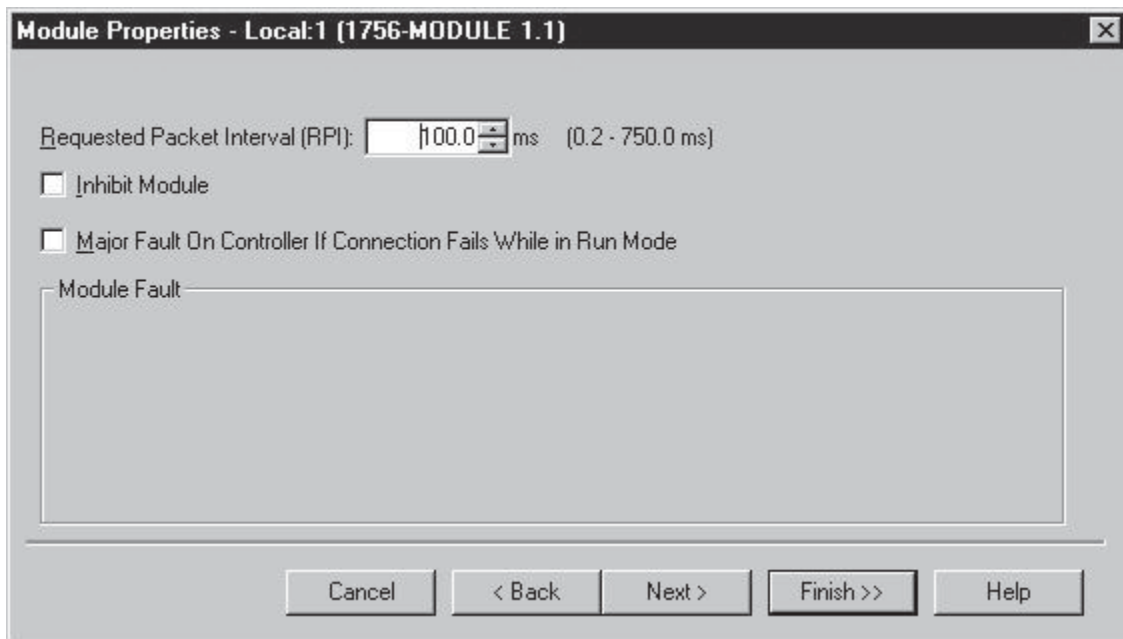

Getting Technical Assistance

If you need technical assistance, please review the information in Chapter 6, “Testing Your Module,” before calling your local distributor of Spectrum Controls.

Note that your module contains electronic components which are susceptible to damage from electrostatic discharge (ESD). An electrostatic charge can accumulate on the surface of ordinary plastic wrapping or cushioning material. **In the unlikely event that the module should need to be returned to Spectrum Controls, please ensure that the unit is enclosed in approved ESD packaging (such as static-shielding / metallized bag or black conductive container).** Spectrum Controls reserves the right to void the warranty on any unit that is improperly packaged for shipment.

For further information or assistance, please contact your local distributor, or call the Spectrum Controls technical Support at :

USA - 440-646-6900

United Kingdom - 01908 635230

Australia - 800-809-929 or (61) 398-990-335

Brazil - (55) 11 3618 8800

Europe - (49) 2104 960 333

Declaration of Conformity

Declaration available upon request.



©2003 Spectrum Controls, Inc. All rights reserved. Specifications subject to change without notice.
The Encompass logo and ControlLogix are trademarks of Rockwell Automation.
Publication 0300199-01 Rev. B December 2003. Printed in U.S.A.

Corporate Headquarters

Spectrum Controls Inc.
P.O. Box 5533
Bellevue, WA 98006 USA
Fax: 425-641-9473
Tel: 425-746-9481

Web Site: www.spectrumcontrols.com
E-mail: spectrum@spectrumcontrols.com

